

New Lines

2022-23

Promotion

Promotion valid until 31st March 2023



www.sealey.co.uk

MMA INVERTER WELDERS
SEE PAGE 28



INDUCTION
HEATER
**SEE
PAGE
21**

**SEE PAGES
29-33**



**FOR NEW ADDITIONS TO OUR 20V
ONE-BATTERY-FITS-ALL RANGE**

Over **600
NEW LINES**
Inside this Promotion

CONTENTS

HAND TOOLS	3 - 11
JACKING & LIFTING	12 - 15
MOTORCYCLE TOOLS	16
BATTERY CHARGERS	17
VEHICLE SERVICE TOOLS	17 - 22
LUBRICATION	23
BODYSHOP	24
AIR POWER TOOLS	25
COMPRESSED AIR SYSTEMS	26 - 27
WELDING & CUTTING	28
ELECTRIC POWER TOOLS	29 - 33
POWER TOOL ACCESSORIES	34 - 35
LIGHTING & POWER	36 - 38
STORAGE & WORKSTATIONS	39 - 43
HEATING & COOLING	44 - 46
JANITORIAL LEISURE	47 - 48
MACHINE SHOP	49 - 51
SAFETY PRODUCTS	52 - 54
CONSUMABLES	55

WHY CHOOSE SEALEY....



- ✓ A comprehensive, continuously expanding product range.
- ✓ Huge stock levels and fast despatch.
- ✓ Value for money – but never at the expense of quality.
- ✓ No quibble long-term and lifetime guarantees*.
- ✓ Unrivalled aftersales service envied throughout the industry.
- ✓ Innovation and continuous product development as standard.
- ✓ Meticulous quality control.
- ✓ Full spare parts back-up service including discontinued products.

Find your
local stockist
by visiting



www.sealey.co.uk/stockist-locator

Or give us a call!

 +44 (0)1284 757500



SEE PAGE 39



SCAN TO ENTER
OUR LATEST
COMPETITIONS!

SOCKET SETS - PLATINUM SERIES

Premier
Platinum series



- Hardened and heat treated Chrome Vanadium steel with a fully polished micro satin finish.
- Colour-coded rings for fast identification.
- Knurled rings assist the gripping of the sockets with oily fingers.
- Supplied with composite socket rail.

Model No.	Drive	Sizes	List Price	Exc. VAT	Inc. VAT
AK2660	3/8" Sq	8-19mm	£36.95	£26.95	£32.34
AK2661	1/2" Sq	10-24mm	£49.95	£35.95	£43.14

9PC 3/8" SQ DRIVE SOCKET BIT SETS - PLATINUM SERIES

Premier
Platinum series



- Forged Chrome Vanadium steel sockets with S2 steel bits.
- Sockets are heat treated and chrome plated with a fully polished micro satin finish.
- Colour-coded rings for fast identification.
- Knurled rings assist the gripping of the sockets with oily fingers.

Model No.	Type	Sizes	List Price	Exc. VAT	Inc. VAT
AK6250	Hex	4-12mm	£29.95	£20.95	£25.14
AK6251	TRX-Star	T10-T50	£28.45	£19.95	£23.94

SOCKET SETS - BLACK SERIES

Premier Black

6pt WALLDRIVE™ MM

3/8" Sq. Drive Model No. AK7993



1/2" Sq. Drive Model No. AK7995



1/4" Sq. Drive Model No. AK7990



- Manufactured from hardened and tempered high grade Chrome Vanadium steel.
- Fully polished black chrome finish for resistance to corrosion.
- Includes knurled ring for extra grip with oily fingers.
- Each set is supplied on a socket rail.

Model No.	Drive	Type	Sizes	List Price	Exc. VAT	Inc. VAT
AK7990	1/4" Sq	Standard	4-14mm	£26.95	£19.95	£23.94
AK7991	1/4" Sq	Deep	4-14mm	£34.95	£24.95	£29.94
AK7992	3/8" Sq	Standard	8-19mm	£31.95	£22.95	£27.54
AK7993	3/8" Sq	Deep	8-19mm	£48.95	£34.95	£41.94
AK7994	1/2" Sq	Standard	10-24mm	£46.95	£33.95	£40.74
AK7995	1/2" Sq	Deep	10-24mm	£65.95	£46.95	£56.34

LOCK-ON™ SOCKET SETS - BLACK SERIES

Premier Black

MM 6pt LOCK-ON

3/8" Sq. Drive Model No. AK2741B



1/2" Sq. Drive Model No. AK2745B



- Manufactured from hardened and tempered high grade Chrome Vanadium steel.
- Fully polished black chrome finish for resistance to corrosion.
- Features specially machined flutes in the walls of the socket which enable use on up to 85% rounded fasteners.
- This not only provides added strength but also prevents damage to worn or rusted fixings.
- Includes knurled ring for extra grip with oily fingers.

LOCK-ON™

Model No.	Drive	Type	Sizes	List Price	Exc. VAT	Inc. VAT
AK2741B	3/8" Sq	Standard	8-19mm	£37.95	£26.95	£32.34
AK2744B	3/8" Sq	Deep	8-19mm	£65.95	£44.95	£53.94
AK2742B	1/2" Sq	Standard	10-24mm	£45.95	£31.95	£38.34
AK2745B	1/2" Sq	Deep	10-24mm	£79.95	£54.95	£65.94

LIFETIME
GUARANTEE

No Quibble Lifetime Guarantee on All Hand Tools*.

Prices exclude VAT unless stated otherwise

SOCKET SETS



Model No. S01243



72-Tooth

1/4" Sq. Drive 3/8" Sq. Drive OR 1/2" Sq. Drive



Model No. S01240

Model No. S01241

Model No. S01242

Model No. S01245

- Chrome Vanadium steel socket sets, hardened and tempered for strength with a fully polished finish for corrosion resistance.
- 72-Tooth pear-head flip reverse ratchet wrenches with quick socket release and comfort grip handle.
- Knurled ring on sockets for extra grip with greasy fingers.
- Supplied on storage/carry rack.

Model No.	Drive	Sockets	List Price	Exc. VAT	Inc. VAT
S01240	1/4" Sq	4, 5, 6, 7, 8, 9, 10, 11, 12, 13mm	£21.95	£13.95	£16.74
S01241	1/4" Sq	4, 4.5, 5, 5.5, 6, 7, 8, 9, 10, 11, 12, 13mm	£32.95	£21.95	£26.34
S01242	3/8" Sq	10, 11, 12, 13, 14, 15, 16, 17, 18, 19mm	£31.95	£20.95	£25.14
S01243	3/8" Sq	6, 7, 8, 9, 10, 11, 12, 13, 14, 15, 16, 17, 18, 19, 20, 21, 22, 24mm	£42.95	£27.95	£33.54
S01244	1/2" Sq	10, 13, 14, 15, 16, 17, 18, 19, 21, 24mm	£44.95	£29.95	£35.94
S01245	1/2" Sq	10, 11, 12, 13, 14, 15, 16, 17, 18, 19, 21, 22, 24, 27, 30, 32mm	£62.95	£42.95	£51.54

SOCKET SETS

- Professional socket sets manufactured from hardened and heat treated Chrome Vanadium steel.
- Fully polished with a mirror finish.
- Includes 72-tooth comfort grip ratchet wrench and extension bars.
- Supplied in tough, durable storage case.



72-Tooth



Model No. S01233 1/4" Sq. Drive



Model No. S01234 1/4" Sq. Drive



Model No. S01235 3/8" Sq. Drive



3/8" Sq. Drive

Model No. S01236



1/2" Sq. Drive

Model No. S01237



Model No.	Drive	Contents	List Price	Exc. VAT	Inc. VAT
S01233	1/4" Sq	1/4" Sq Drive Standard Sockets; 4, 4.5, 5, 5.5, 6, 7, 8, 9, 10, 11, 12, 13mm, 1/4" Sq Drive Bits; TRX-Star* - T10, T15, T20, T25, T30, T40, Phillips - #1, #2, Hex - 5, 6mm, 1/4" Sq Drive Extension Bar; 100mm, 1/4" Sq Drive Adaptor, 1/4" Sq Drive Ratchet Wrench	£24.95	£17.95	£21.54
S01234	1/4" Sq	1/4" Sq Drive Standard Sockets; 4, 4.5, 5, 5.5, 6, 7, 8, 9, 10, 11, 12, 13, 14mm, 1/4" Sq Drive Deep Sockets; 6, 7, 8, 9, 10, 11, 12, 13mm, 1/4" Sq Drive Extension Bars; 75, 150mm, 1/4" Sq Drive Universal Joint, 1/4" Sq Drive Spinner, 1/4" Sq Drive Ratchet Wrench	£39.95	£28.95	£34.74
S01235	3/8" Sq	3/8" Sq Drive Standard Sockets; 8, 9, 10, 11, 12, 13, 14, 15, 16, 17, 18, 19, 21, 22mm, 3/8" Sq Drive Extension Bars; 75, 150mm, 3/8" Sq Universal Joint, 3/8" Sq Drive Adaptor, 3/8" Sq Drive Ratchet Wrench	£44.95	£31.95	£38.34
S01236	3/8" Sq	Standard Sockets; 8, 9, 10, 11, 12, 13, 14, 15, 16, 17, 18, 19, 21, 22mm, Deep Sockets; 10, 11, 12, 13, 14, 15, 16, 17, 18, 19mm, 3/8" Sq Drive Flip Reverse Quick Release Ratchet Wrench, Extension Bars; 75, 150mm, Universal Joint	£59.95	£42.95	£51.54
S01237	1/2" Sq	1/2" Sq Drive Standard Sockets; 10, 11, 12, 13, 14, 15, 16, 17, 18, 19, 21, 22, 24, 27, 30, 32mm, 1/2" Sq Drive Extension Bars; 125, 250mm, 1/2" Sq Universal Joint, 1/2" Sq Drive Adaptor, 1/2" Sq Drive Ratchet Wrench	£74.95	£53.95	£64.74

1/2"SQ DRIVE IMPACT SOCKET SETS

Premier

1/2" Sq. Drive

MM

6pt WALLDRIVE®



Model No. AK5618M



Model No. AK5617M



Model No. AK5818M



- Manufactured from Chrome Vanadium steel, hardened, tempered and with a phosphate finish for added corrosion resistance.
- Deep 6-point WallDrive® sockets allows a transfer of up to 30% more torque to the fixing.
- Colour-coded rings for fast identification.
- AK5617M and AK5818M supplied in storage case.
- AK5618M supplied on socket rail.

Model No.	Qty	Depth	Sizes	List Price	Exc. VAT	Inc. VAT
AK5618M	9pc	Standard	10-24mm	£41.95	£26.95	£32.34
AK5617M	13pc	Standard	10-24mm	£59.95	£39.95	£47.94
AK5818M	16pc	Deep	10-32mm	£109.95	£69.95	£83.94

3/4"SQ DRIVE 12-POINT WALLDRIVE® SOCKET SETS

Premier

3/4" Sq. Drive

DUAL FINISH

12pt WALLDRIVE®

MM

Model No. AK2583



- Manufactured from heat treated drop-forged Chrome Vanadium steel.
- Hardened and tempered with dual satin chrome finish.
- WallDrive® sockets grip the flats of the fixing giving maximum torque transfer.
- Features pear-head flip reverse ratchet wrenches with quick release.
- Includes sliding T-bar and extension bars.

Model No.	Qty	Type	List Price	Exc. VAT	Inc. VAT
AK2583	15pc	Metric	£259.95	£189.95	£227.94
AK2584	26pc	Metric/Imperial	£319.95	£229.95	£275.94

Model No. AK2584 MM & IMP

CAR MECHANICS BEST BUY

144PC MECHANIC'S TOOL KIT HI-VIS GREEN

Premier

1/4", 3/8" & 1/2" Sq. Drive

6pt WALLDRIVE®

MM



- Comprehensive range of frequently used hand tools.
- 1/4" and 1/2" Sq drive 72-Tooth offset comfort grip ratchet wrenches.
- Includes 1/4", 3/8" and 1/2" Sq drive sockets, hex keys, spanners, screwdrivers, pliers, bits and accessories.
- Housed in a sturdy storage case with reinforced corners, aluminium trim and lockable metal catches.
- Case Size (W x D x H): 465 x 395 x 105mm.
- Model No. AK7980HV
- List Price £299.95

£189.95 Exc. VAT
£227.94 Inc. VAT



LIFETIME GUARANTEE

No Quibble Lifetime Guarantee on All Hand Tools*

Prices exclude VAT unless stated otherwise

3PC MICROMETER STYLE TORQUE WRENCH SET

Premier 1/4", 3/8" & 1/2" Sq. Drive

- Ranges: 1/4" Sq Drive 5-25Nm, 3/8" Sq Drive 20-120Nm and 1/2" Sq Drive 40-220Nm.
- Flip reverse Chrome Vanadium steel ratchet head with smooth action mechanism.
- Scales graduated in both Nm and lb.ft.
- Wrenches are individually tested to standards with ±4% accuracy and each wrench is issued with an individually numbered test certificate.
- Aluminium knurled handle for comfort and control.
- **Model No. STW900SET**
- List Price £269.95

£154.95 Exc. VAT
£185.94 Inc. VAT



WHEEL FITTING & ALIGNMENT TOOL

- Designed to assist with the lifting and locating of road wheels on to vehicle hubs and intended to be used where there is no access to a vehicle lift, such as by the roadside.
- Significantly reduces lifting strain whilst notably improving body posture.
- Supplied with four CNC machined stainless steel adaptor pegs complete with storage holder.
- Suitable for most cars, light goods vehicles, motor homes and caravans.
- Polypropylene and TPV rubber soft grip handle for comfort and control.
- For use on alloy or steel wheels up to 35kg.
- Patent Pending.
- **Model No. AK7500**
- List Price £39.95



£31.95 Exc. VAT
£38.34 Inc. VAT



Reduces the effort required to lift a wheel by up to 80% and takes less than half the usual time taken to change a wheel.



RATCHET WRENCHES - PREMIER BLACK



1/4" Sq. Drive | 3/8" Sq. Drive | OR | 1/2" Sq. Drive

- Heat treated and hardened Chrome Vanadium steel.
- Fully polished black chrome finish steel with machined and lacquered heads.
- 72-tooth flip reverse ratchet wrench with push-button quick release.

Model No.	Drive	List Price	Exc. VAT	Inc. VAT
AK7997	1/4" Sq	£22.95	£15.95	£19.14
AK7998	3/8" Sq	£29.95	£21.95	£26.34
AK7999	1/2" Sq	£37.95	£26.95	£32.34



Model No. AK7998

1/2" SQ DRIVE BREAKER BARS

- Hardened and tempered Chrome Vanadium steel bars with high chrome finish.
- Long, slim style handle and spring loaded socket retention.
- Comfortable soft grip handle.
- Fully replaceable knuckle joint*.

Premier

1/2" Sq. Drive



750mm Length

Model No. AK7307HV

600mm Length

Model No. AK7306

*Note: Knuckle joints are not covered by the lifetime guarantee and are treated as consumable items.

Model No.	Colour	Length	List Price	Exc. VAT	Inc. VAT
AK7306	Red	600mm	£34.95	£17.95	£21.54
AK7306HV	Hi-Vis Green	600mm	£34.95	£17.95	£21.54
AK7307	Red	750mm	£39.95	£23.95	£28.74
AK7307HV	Hi-Vis Green	750mm	£39.95	£23.95	£28.74

RATCHET WRENCH SETS

- Chrome Vanadium steel 72-tooth ratchet wrench set, hardened and tempered, with a fully polished mirror finish.
- Features pear-head with flip reverse, push-button quick release and anti-slip comfort grip.

72-Tooth **Siegen**

5PC 3/8" SQ DRIVE RATCHET WRENCH SET

3/8" Sq. Drive

- Contents: Regular Ratchet Wrench, Offset Regular Ratchet Wrench, Stubby Ratchet Wrench, 457mm Extra-Long Ratchet Wrench, 457mm Extra-Long Flexi-Head Ratchet Wrench.
- **Model No. S01230**
- List Price £114.95

£69.95 Exc. VAT
£83.94 Inc. VAT



4PC 1/2" SQ DRIVE RATCHET WRENCH SET

1/2" Sq. Drive

- Contents: Regular Straight Quick Release Ratchet, Offset Quick Release Ratchet, 610mm Extra-Long Straight Quick Release Ratchet, 610mm Extra-Long Flexi-Head Quick Release Ratchet.
- **Model No. S01231**
- List Price £129.95

£89.95 Exc. VAT
£107.94 Inc. VAT



12PC COMBINATION SPANNER SET



- Drop-forged Chrome Vanadium steel combination spanners.
- Hardened, tempered and fully polished mirror finish for corrosion resistance.
- Open-end and 12-point WallDrive® ring combination.
- Sizes: 8, 9, 10, 11, 12, 13, 14, 15, 16, 17, 18, 19mm.
- Supplied in storage/carry rack.
- **Model No. S01246**
- List Price £32.95



£21.95 Exc. VAT
£26.34 Inc. VAT

15PC COMBINATION RATCHET SPANNER SET

72-Tooth



- Chrome Vanadium steel ratchet combination spanner set.
- 72-Tooth ratchet ring and gear set requiring only 5° rotation to pick up the next tooth, ideal for applications where space is limited.
- Sizes: 8, 9, 10, 11, 12, 13, 14, 15, 16, 17, 18, 19, 21, 22, 24mm.
- Supplied in EVA storage tray.
- **Model No. S01247**
- List Price £99.95



£64.95 Exc. VAT
£77.94 Inc. VAT

COMBINATION SPANNER SETS



MM

Model No. AK63265

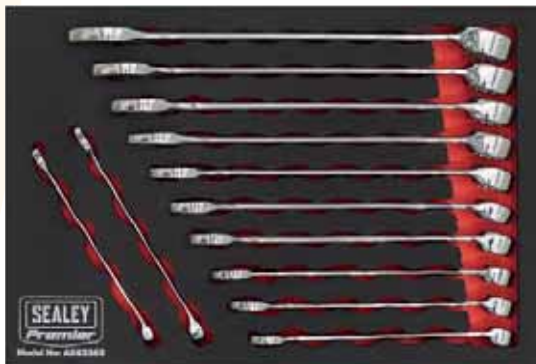

IMP

Model No. AK63266

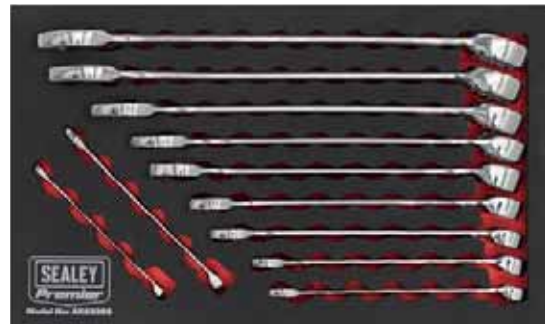

- Chrome Vanadium steel combination spanners.
- Hardened, tempered and nickel chrome plated for corrosion resistance.
- Fully polished mirror finish.
- Open-end and 12-point WallDrive® ring combination.
- Supplied in EVA storage tray.

Model No.	Type	Sizes	List Price	Exc. VAT	Inc. VAT
AK63265	Metric	8, 9, 10, 11, 12, 13, 14, 15, 16, 17, 18, 19mm	£44.95	£27.95	£33.54
AK63266	Imperial	1/4", 5/16", 3/8", 7/16", 1/2", 9/16", 5/8", 11/16", 3/4", 13/16", 7/8"	£44.95	£27.95	£33.54

580mm SLATER'S RIPPER

- Remove and repair broken roof slates.
- Bevelled hook edges for sliding under nail head.
- Hardened and spring tempered steel.
- Tough and durable.
- **Model No. SR700**
- List Price £14.95

£10.95 Exc. VAT
£13.14 Inc. VAT

Ø110mm MAGNETIC COLLECTOR



Magnetic



- Ø110mm Stainless steel tray with Ø60mm magnet in non-marking cover.
- Ideal for storing nuts, bolts, screws, washers and sockets during disassembly/assembly.
- Attaches to any ferrous surface and even works upside-down.
- **Model No. AK2311**
- List Price £5.95

£3.95 Exc. VAT
£4.74 Inc. VAT

27PC MASTER HEX KEY SET



- Manufactured from heat treated and hardened Chrome Vanadium steel with a fully polished finish.
- Anti-slip coating for comfort and control.
- Each key set is supplied in easy-access case for safe storage and quick key selection.
- Supplied in an EVA storage tray.
- **Model No. AK7179**
- List Price £59.95

1/16"-3/8" T10 - T50

£39.95 Exc. VAT
£47.94 Inc. VAT



No Quibble Lifetime Guarantee on All Hand Tools*

Prices exclude VAT unless stated otherwise



3PC GRIPMAX® STUBBY SCREWDRIVER SET HI-VIS GREEN

Premier

- High quality Chrome Vanadium satin finished shaft with shot blasted and magnetized tips.
- Ideal for use in tight spaces.
- Includes hanging holes for alternative storage.
- Contents: Slotted; 6 x 38mm, Phillips; #2 x 38mm, Pozi; #2 x 38mm.
- **Model No. AK4328HV**
- List Price £9.45



£5.95 Exc. VAT
£7.14 Inc. VAT



Ergonomic polypropylene and TPV rubber soft grip handles maximize power transfer from hand to fixing.

33PC GRIPMAX® SCREWDRIVER & BIT SETS

Premier

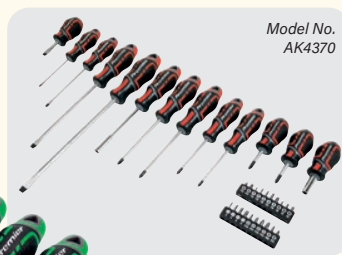

Model No. AK4370



Model No. AK4370HV

- High quality Chrome Vanadium steel satin finished shafts with shot blasted and magnetized tips.
- Each size clearly marked for quick and easy identification.
- Includes hanging holes for alternative storage.
- **Model No. AK4370HV - Hi-Vis Green**
- **Model No. AK4370 - Red**
- List Price £54.95

£34.95 Exc. VAT
£41.94 Inc. VAT

9PC GRIPMAX® HAMMER-THRU SCREWDRIVER SETS

Premier

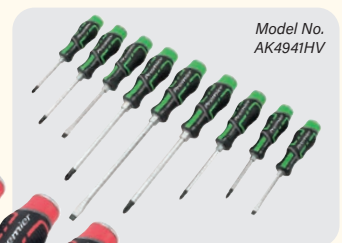

Model No. AK4941HV



Model No. AK4941

- High quality Chrome Vanadium steel satin finished shafts with shot blasted and magnetized tips.
- Features hexagonal bolster for use with a wrench.
- Contoured, textured soft-grip handles with hammer caps.
- **Model No. AK4941 - Red**
- **Model No. AK4941HV - Hi-Vis Green**
- List Price £72.95

£44.95 Exc. VAT
£53.94 Inc. VAT

6PC GRIPMAX® HAMMER-THRU SCREWDRIVER SETS

Premier



Model No. AK4940



Model No. AK4940HV

- High quality Chrome Vanadium steel satin finished shafts with shot blasted and magnetized tips.
- Features hexagonal bolster for use with a wrench.
- Contoured, textured soft-grip handles with hammer caps.
- **Model No. AK4940HV - Hi-Vis Green**
- **Model No. AK4940 - Red**
- List Price £47.95

£29.95 Exc. VAT
£35.94 Inc. VAT

3PC GRIPMAX® 450MM EXTRA-LONG HAMMER-THRU SCREWDRIVER SETS

Premier



450mm Length



Model No. AK4942HV

- High quality Chrome Vanadium steel extra-long satin finished shafts with shot blasted and magnetized tips.
- Features hexagonal bolster for use with a wrench.
- Contoured, textured soft-grip handles with hammer caps.
- Contents: Slotted; 8 x 450mm, Phillips; #2 x 450, #3 x 450mm.
- **Model No. AK4942 - Red**
- **Model No. AK4942HV - Hi-Vis Green**
- List Price £46.95

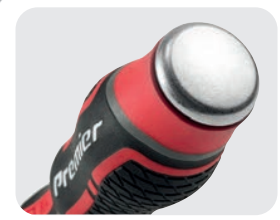

Model No. AK4942

£29.95 Exc. VAT
£35.94 Inc. VAT

IMPACT GRADE POWER TOOL BIT SETS

Premier



A - G

B + D

- Popular range of impact grade power tool bits and accessories for the professional user.
- Forged from high quality S2 steel.
- Specially heat treated CNC precision machined tips reduce stress and prevent cam-out under load.
- Torsion bits absorb impact and transfer maximum torque to the fixing.
- Supplied in storage cases.



Ref.	Model No.	Contents	List Price	Exc. VAT	Inc. VAT
A	AK8286	25mm Bits; Slotted - 4.5, 5.5, 6.5mm, Phillips - #1, #2 (x3), #3, Pozi - #1, #2 (x3), #3 (x2), TRX-Star* - T10, T15 (x2), T20 (x2), T25 (x3), T27, T30 (x3), T40, Hex - 3, 4, 5, 6mm, 60mm Bit Holder	£24.95	£17.95	£21.54
B	AK8280	25mm Bits; Slotted - 5.5mm, 6.5mm, Phillips - #1, #2 (x4), #3 (x2), Pozi - #1, #2 (x4), #3 (x3), TRX-Star* - T10, T15, T20 (x2), T25 (x2), T27, T30 (x3), T40, Hex - 4, 5, 6mm, Square - #2, 50mm Bits; Slotted - 5.5mm, Phillips - #2, Pozi - #2, #3, TRX-Star* - T25, T30, Hex - 6mm, 60mm Bit Holder, 75mm Screw Guide, Nut Setter - 6, 8mm, 3/8" Sq Drive Socket Adaptor	£39.95	£26.95	£32.34
C	AK8281	25mm Bits; Slotted - 4.5mm (x2), 5.5mm (x2), 6.5mm (x2), Phillips - #1 (x2), #2 (x4), #3 (x2), Pozi - #1 (x3), #2 (x5), #3 (x2), TRX-Star* - T10 (x2), T15 (x2), T20 (x4), T25 (x4), T30 (x4), T40 (x2), Hex - 4 (x2), 5 (x2), 6mm (x2), 50mm Bits; Phillips - #2, Pozi - #1, #2, TRX-Star* - T20, T25, T30, 60mm Bit Holder	£39.95	£26.95	£32.34
D	AK8282	25mm Bits; Slotted - 5.5, 6.5mm, Phillips - #1, #2 (x3), #3, Pozi - #1, #2 (x3), #3 (x2), TRX-Star* - T20 (x2), T25 (x3), T30 (x3), Hex - 5, 6mm, Square - #2, 50mm Bits; Slotted - 5.5mm, Phillips - #2, #3, Pozi - #2, #3, TRX-Star* - T15, T20, T25, T30, Hex - 6mm, 75mm Bits; Phillips - #2, Pozi - #2, TRX-Star* - T25, 60mm Bit Holder	£34.95	£23.95	£28.74
E	AK8283	25mm Bits; Slotted - 5.5mm, Phillips - #2, Pozi - #1, #2 (x2), #3, TRX-Star* - T10, T15, T20 (x2), T25 (x2), T30, T40, Hex - 5, 6mm, 50mm Bits; Phillips - #2, Pozi; #2 (x2), #3, TRX-Star* - T20, T25, T30, 75mm Bits; Slotted - 5.5mm, Phillips - #2, Pozi - #2, TRX-Star* - T20, T25, T30, Hex - 5mm, Impact Bit Holder, Quick Release Impact Bit Holder, Nut Setter - 6, 8, 10mm	£39.95	£26.95	£32.34
F	AK8284	25mm Bits; Phillips - #1, #2 (x2), #3, Pozi - #1, #2 (x2), #3, TRX-Star* - T15, T20 (x2), T25 (x2), T30, Hex - 4, 5mm, 50mm Bits; Slotted - 5.5mm, Phillips - #2, Pozi - #2, #3, TRX-Star* - T20, T25, T30, 60mm Bit Holder, 75mm Screw Guide, Hex Shank Drill Bits - 2.5, 3, 3.5, 4, 4.5, 4.8, 5mm, Nut Setter - 6, 8, 10mm	£44.95	£29.95	£35.94
G	AK8285	25mm Bits; Phillips - #2, #3, Pozi - #1, #2, #3, TRX-Star* - T20, T25, T30, 50mm Bits; Slotted - 5.5mm, Phillips - #1, #2 (x3), #3, Pozi - #1, #2 (x4), #3, TRX-Star* - T15, T20 (x2), T25 (x2), T30 (x2), Hex - 5, 6mm, 60mm Bit Holder, Quick Release Bit Holder, Socket Adaptor - 1/4" Sq Drive, 3/8" Sq Drive, 1/2" Sq Drive	£39.95	£26.95	£32.34



No Quibble Lifetime Guarantee on All Hand Tools*

Prices exclude VAT unless stated otherwise

IMPACT POWER TOOL BITS



- Impact grade power tool bits for the professional user.
- Forged from high quality S2 steel.
- Specially heat treated CNC precision machined tips reduce stress and prevent cam-out under load.
- Torsion bits absorb impact and transfer maximum torque to the fixing.

3pc Slotted Impact Power Tool Bits						
Model No.	Size	Length	List Price	Exc. VAT	Inc. VAT	
AK8201	4.5mm	25mm	£1.95	£1.45	£1.74	
AK8202	5.5mm	25mm	£1.95	£1.45	£1.74	
AK8203	6.5mm	25mm	£1.95	£1.45	£1.74	
AK8226	4.5mm	50mm	£2.75	£1.95	£2.34	
AK8227	5.5mm	50mm	£2.75	£1.95	£2.34	
AK8228	6.5mm	50mm	£2.75	£1.95	£2.34	
AK8251	4.5mm	75mm	£3.75	£2.75	£3.30	
AK8252	5.5mm	75mm	£3.75	£2.75	£3.30	
AK8253	6.5mm	75mm	£3.75	£2.75	£3.30	

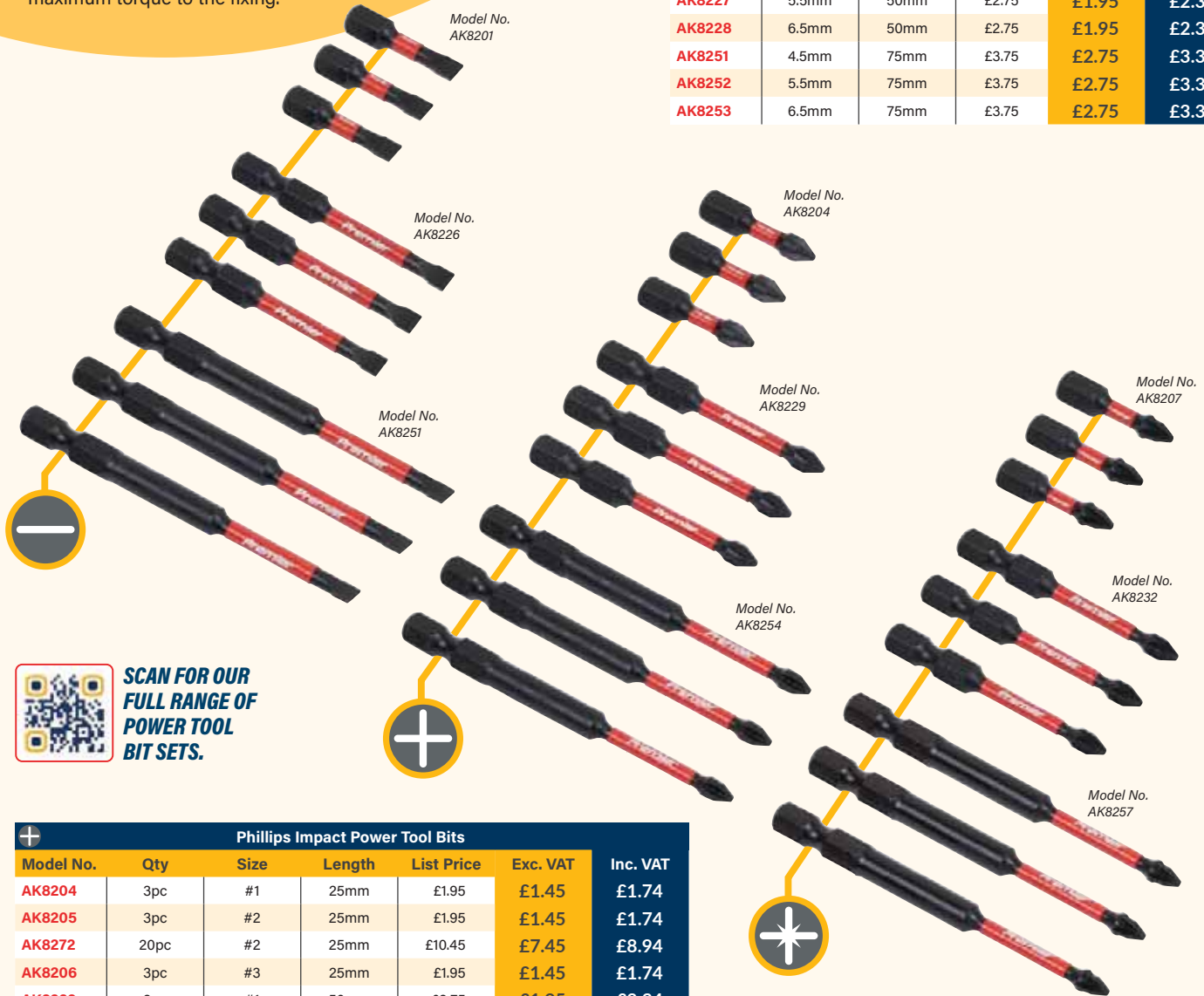

SCAN FOR OUR FULL RANGE OF POWER TOOL BIT SETS.

Phillips Impact Power Tool Bits						
Model No.	Qty	Size	Length	List Price	Exc. VAT	Inc. VAT
AK8204	3pc	#1	25mm	£1.95	£1.45	£1.74
AK8205	3pc	#2	25mm	£1.95	£1.45	£1.74
AK8272	20pc	#2	25mm	£10.45	£7.45	£8.94
AK8206	3pc	#3	25mm	£1.95	£1.45	£1.74
AK8229	3pc	#1	50mm	£2.75	£1.95	£2.34
AK8230	3pc	#2	50mm	£2.75	£1.95	£2.34
AK8274	10pc	#2	50mm	£9.95	£6.95	£8.34
AK8231	3pc	#3	50mm	£2.75	£1.95	£2.34
AK8254	3pc	#1	75mm	£3.75	£2.75	£3.30
AK8255	3pc	#2	75mm	£3.75	£2.75	£3.30
AK8256	3pc	#3	75mm	£3.75	£2.75	£3.30

Pozi Impact Power Tool Bits						
Model No.	Qty	Size	Length	List Price	Exc. VAT	Inc. VAT
AK8207	3pc	#1	25mm	£1.95	£1.45	£1.74
AK8208	3pc	#2	25mm	£1.95	£1.45	£1.74
AK8273	20pc	#2	25mm	£10.45	£7.45	£8.94
AK8209	3pc	#3	25mm	£1.95	£1.45	£1.74
AK8232	3pc	#1	50mm	£2.75	£1.95	£2.34
AK8233	3pc	#2	50mm	£2.75	£1.95	£2.34
AK8275	10pc	#2	50mm	£9.95	£6.95	£8.34
AK8234	3pc	#3	50mm	£2.75	£1.95	£2.34
AK8257	3pc	#1	75mm	£3.75	£2.75	£3.30
AK8258	3pc	#2	75mm	£3.75	£2.75	£3.30
AK8259	3pc	#3	75mm	£3.75	£2.75	£3.30



Model No. AK8273

6PC IMPACT GRADE NUT DRIVER SET

Premier 6-13mm

- Forged from high quality Chrome Vanadium steel.
- Contents: 6, 7, 8, 10, 12, 13mm.
- Drive: 1/4"Hex.
- **Model No. AK8287**
- List Price £29.95

£21.95 Exc. VAT
£26.34 Inc. VAT



Model No.	Size	Length	List Price	Exc. VAT	Inc. VAT
AK8210	2.5mm	25mm	£1.95	£1.45	£1.74
AK8211	3mm	25mm	£1.95	£1.45	£1.74
AK8212	4mm	25mm	£1.95	£1.45	£1.74
AK8213	5mm	25mm	£1.95	£1.45	£1.74
AK8214	6mm	25mm	£1.95	£1.45	£1.74
AK8235	2.5mm	50mm	£2.75	£1.95	£2.34
AK8236	3mm	50mm	£2.75	£1.95	£2.34
AK8237	4mm	50mm	£2.75	£1.95	£2.34
AK8238	5mm	50mm	£2.75	£1.95	£2.34
AK8239	6mm	50mm	£2.75	£1.95	£2.34
AK8260	2.5mm	75mm	£3.75	£2.75	£3.30
AK8261	3mm	75mm	£3.75	£2.75	£3.30
AK8262	4mm	75mm	£3.75	£2.75	£3.30
AK8263	5mm	75mm	£3.75	£2.75	£3.30
AK8264	6mm	75mm	£3.75	£2.75	£3.30

Model No.	Size	Length	List Price	Exc. VAT	Inc. VAT
AK8215	T10	25mm	£1.95	£1.45	£1.74
AK8216	T15	25mm	£1.95	£1.45	£1.74
AK8217	T20	25mm	£1.95	£1.45	£1.74
AK8218	T25	25mm	£1.95	£1.45	£1.74
AK8219	T27	25mm	£1.95	£1.45	£1.74
AK8220	T30	25mm	£1.95	£1.45	£1.74
AK8221	T40	25mm	£1.95	£1.45	£1.74
AK8240	T10	50mm	£2.75	£1.95	£2.34
AK8241	T15	50mm	£2.75	£1.95	£2.34
AK8242	T20	50mm	£2.75	£1.95	£2.34
AK8243	T25	50mm	£2.75	£1.95	£2.34
AK8244	T27	50mm	£2.75	£1.95	£2.34
AK8245	T30	50mm	£2.75	£1.95	£2.34
AK8246	T40	50mm	£2.75	£1.95	£2.34
AK8265	T10	75mm	£3.75	£2.75	£3.30
AK8266	T15	75mm	£3.75	£2.75	£3.30
AK8267	T20	75mm	£3.75	£2.75	£3.30
AK8268	T25	75mm	£3.75	£2.75	£3.30
AK8269	T27	75mm	£3.75	£2.75	£3.30
AK8270	T30	75mm	£3.75	£2.75	£3.30
AK8271	T40	75mm	£3.75	£2.75	£3.30

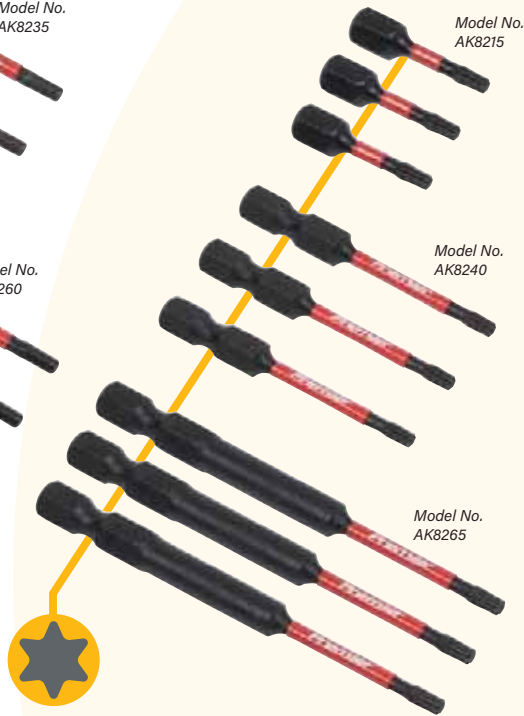
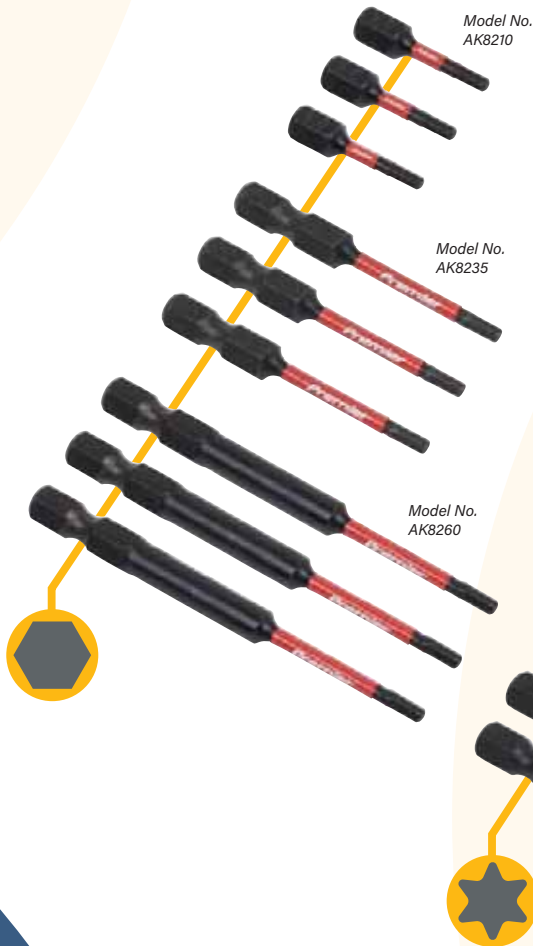

No Quibble Lifetime Guarantee on All Hand Tools*

Prices exclude VAT unless stated otherwise

2 TONNE LOW PROFILE SHORT CHASSIS TROLLEY JACK WITH 180° HANDLE



180° turning handle allows use even in tight spaces.



- Min./Max. Saddle Height: 100/350mm.
- Chassis Length: 490mm.
- Heavy-duty chassis with strengthening flanges along the top edge for extra torsional rigidity under load.
- Profiled lifting arm allows low clearance height of just 100mm making this unit suitable for sports and custom cars.
- Fitted with heavy-duty one-piece hydraulic unit with pump-through action preventing handle locking at maximum ram extension.
- White saddle aids positioning under vehicle and safety valve prevents overloading.
- **Model No. 2180LE**
- List Price £83.95



2tonne

LOW PROFILE 100mm

£64.95 Exc. VAT
£77.94 Inc. VAT

RATCHET TYPE AXLE STANDS (PAIR) 3 TONNE CAPACITY PER STAND HI-VIS GREEN

3tonne



- Min./Max. Working Height: 295/430mm.
- Capacity: 6tonne per pair.
- Ratchet type with cast iron support posts.
- Tough steel-plate welded bases.
- Sold in pairs.
- **Model No. VS2003HV**
- List Price £53.95

£39.95 Exc. VAT
£47.94 Inc. VAT

2 TONNE SHORT CHASSIS TROLLEY JACK HI-VIS GREEN

2tonne

Short Chassis

- Min./Max. Saddle Height: 130/330mm.
- Chassis Length: 450mm.
- Steel chassis with welded castor supports and one-piece hydraulic unit.
- Fitted with overload valve and finger cover for extra safety.
- Suitable for the hobby user or as an emergency mobile jack.
- Model No. 1050CXDHV Supplied in tough storage case to keep dirty jack away from contents of car boot.



Model No. 1050CXDHV

Model No.	Storage case	List Price	Exc. VAT	Inc. VAT
1050CXHV	X	£57.95	£41.95	£50.34
1050CXDHV	✓	£62.95	£46.95	£56.34

3 TONNE LOW ENTRY TROLLEY JACKS WITH ROCKET LIFT

3tonne

UNIVERSAL JOINT RELEASE

LOW PROFILE 85mm

ROCKET LIFT



- Min./Max. Saddle Height: 85/500mm.
- Twin piston Rocket Lift feature brings saddle to maximum height in minimal strokes.
- Universal joint release mechanism allows safer, more controlled lowering of jack.
- Profiled lifting arm gives low clearance height of just 85mm making it suitable for sports and custom cars.
- Fitted with an overload valve for added safety.
- **Model No. 3000LE - Red**
- **Model No. 3000LEHV - Hi-Vis Green**
- List Price £239.95



£174.95 Exc. VAT
£209.94 Inc. VAT

HIGH LEVEL SUPPLEMENTARY SUPPORT STANDS



Model No. ASH4000

- Model No. ASH2000 Min./Max. Working Height: 1210/1795mm.
- Model No. ASH4000 Min./Max. Working Height: 1200/1862mm.
- Steel stand.
- Pin and chain load support.
- Full width crutch.
- Designed to support part of a vehicle that is being used on a lift where free access is required.
- Stands also help prevent the tipping/rocking of the vehicle.
- These stands should not be used to support a vehicle on their own. Sold as singles, but MUST be used in pairs.

Model No.	Capacity	List Price	Exc. VAT	Inc. VAT
ASH2000	2 Tonne	£339.95	£279.95	£335.94
ASH4000	4 Tonne	£369.95	£299.95	£359.94



Model No. ASH4000

HIGH LEVEL



SUBFRAME/ENGINE LOAD ADAPTOR FOR TTI TRANSMISSION JACKS

- Fully adjustable Subframe/Engine support adaptor.
- To assist in the removal and fitting of complete engine assemblies, rear axles, gearboxes, fuel tanks, exhaust systems and other awkward loads.
- Designed to fit directly on to the Sealey 500TTJ and 800TTJ Transmission Jacks.
- **Model No. SFC01**
- List Price £359.95

£289.95 Exc. VAT
£347.94 Inc. VAT



450kg Capacity

LAND ROVER DEFENDER FARM JACK ADAPTER



- Adapter suitable for all farm jacks.
- For use on Land Rover Defenders with jacking point tube.
- **Model No. FJLR**
- List Price £29.95

£23.95 Exc. VAT
£28.74 Inc. VAT

2 TONNE AIR JACKING BEAM WITH 1.6M EXTENDING ARMS & FLAT ROLLER SUPPORTS



**BEAM LIFT:
95-300mm.**

2tonne

- Lifts load with compressed air.
- Air Pressure: 90-145psi.
- Fully certified and approved to comply with MOT requirements.
- 1.6m Load arm reach.
- 2-Stage mechanical safety lock and telescopic finger guards.
- Spring loaded flat arms with roller bearings.
- Optional hook arms supplied.
- Supplied with two pairs of aluminium support blocks.
- This item is heavy. Extra assistance must be provided at the delivery point to help its safe delivery.
- **Model No. SJBEX200A**
- List Price £1,399.95



£999.95 Exc. VAT
£1,199.94 Inc. VAT

0.5 TONNE ADJUSTABLE PORTABLE GANTRY CRANE COMBO



- Package includes:**
- SG500 - 0.5 Tonne Adjustable Portable Gantry Crane
 - PT500 - 0.5 Tonne Trolley Plain
 - CB500 - 0.5 Tonne Chain Block 2.5m
 - **Model No. SG500KIT**
 - List Price £759.95

£599.95 Exc. VAT
£719.94 Inc. VAT

2 TONNE ADJUSTABLE PORTABLE GANTRY CRANE COMBO



- Package includes:**
- SG2000W - 2 Tonne Adjustable Portable Gantry Crane
 - PT2000 - 2 Tonne Trolley Plain
 - CB2000 - 2 Tonne Chain Block 3m
 - **Model No. SG2000KIT**
 - List Price £1,599.95

£1,199.95 Exc. VAT
£1,439.94 Inc. VAT



This item is heavy. Extra assistance must be provided at the delivery point to help its safe delivery.

Model No. SG2000W



Model No. SG2000W

PORTABLE ADJUSTABLE GANTRY CRANES

- Four swivel locking castors.
- Winch assisted height-adjustments (unladen) from 2400 to 3600mm in 100mm increments.
- All steel construction.
- 'I' beam cross member for added strength.
- Ideal for maintenance, manufacturing, repairs and other material handling tasks.
- Quick assembly and disassembly for easy transport within a workplace or from site to site.
- Gantry crane is NOT to be moved while loaded.
- Lifting tackle not included.

Model No.	Max. Load Capacity	List Price	Exc. VAT	Inc. VAT
SG500	0.5tonne	£599.95	£499.95	£599.94
SG2000W	2tonne	£1,299.95	£999.95	£1,199.94

MECHANIC'S UTILITY SEAT HI-VIS GREEN



- Steel framework with powder coated finish.
- Extra thick cushioned padding.
- Ø63mm Rubber castors with ball-bearing swivel.
- Composite storage tray.
- **Model No. SCR9HV**
- List Price £59.95

£43.95 Exc. VAT
£52.74 Inc. VAT

EV BATTERY LIFT/HYDRAULIC PLATFORM TRUCK HIGH LIFT 700KG CAPACITY

- Heavy-duty construction.
- Fitted with four composite wheels, two fixed and two locking castors for easy-rolling over rough workshop floors.
- One-piece hydraulic unit controlled by large rear mounted foot pedal.
- Designed to assist with removing and installing batteries in electric vehicles.
- Safety release mechanism positioned on handlebar for smooth controlled descent.
- May also be used as a mobile service bench.
- This item is heavy. Extra assistance must be provided at the delivery point to help its safe delivery.
- Platform Size: 610 x 1220mm.
- **Model No. EVBT700**
- List Price £1,399.95



Maximum lift height 1.5m



£1,199.95 Exc. VAT
£1,439.94 Inc. VAT

12V ATV WINCH 1000KG LINE PULL

- Suitable for ATV mounting.
- 3-Stage planetary gears.
- 12V DC 1.2hp Permanent magnet motor.
- Pull and turn clutch.
- 4-Way roller fairlead for even distribution of cable onto drum.
- Cable Length: 12m.
- **Model No. ATV1000W**
- List Price £139.95



£109.95 Exc. VAT
£131.94 Inc. VAT

MECHANIC'S DETAILING UTILITY SEATS

- Easy-rolling Ø100mm rubber castors with ball-bearing swivel.
- SCR90 and SCR92 Feature extra thick cushioned padding for added comfort when seated.



- Cup/bottle holders and storage trays for tools and components.
- **Model No. SCR90**
- List Price £129.95

£109.95 Exc. VAT
£131.94 Inc. VAT

- Supplied with six interchangeable cup/bottle holders and storage trays for tools and components.
- **Model No. SCR91**
- List Price £99.95

£79.95 Exc. VAT
£95.94 Inc. VAT

- Storage trays and sliding drawer for tools and components.
- **Model No. SCR92**
- List Price £109.95

£89.95 Exc. VAT
£107.94 Inc. VAT

VIKING HYDRAULIC PRESSES

- Professional range of floor and bench mount presses, ranging from 15 tonne to 100 tonne.
- Hydraulic elements are mounted in the frame to maximize workspace and protect components.
- Storage for press pins included in frame.



These items are heavy. Extra assistance must be provided at the delivery point to help their safe delivery.



A 15tonne **Hydraulic** **B** 20tonne **Hydraulic** **C** 30tonne **Hydraulic**

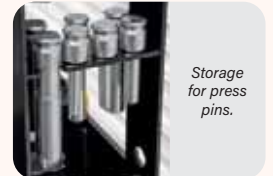
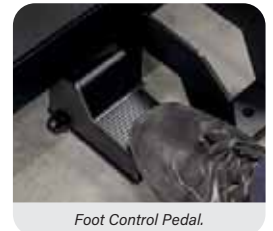

D 30tonne **AIR Hydraulic** **E** 50tonne **AIR Hydraulic** **F** 100tonne **AIR Hydraulic**

Ref.	Model No.	Capacity	Press Type	Table Aperture	Working Table Width	Ram Stroke	Lateral Travel	Press Pins (Supplied)	List Price	Exc. VAT	Inc. VAT
A	PPB15S	15tonne	Bench Mounting - Hydraulic	147mm	565mm	95mm	-	✓	£689.95	£579.95	£695.94
B	PPF20S	20tonne	Floor Standing - Hydraulic	150mm	710mm	145mm	-	✓	£1,199.95	£999.95	£1,199.94
C	PPF30S	30tonne	Floor Standing - Hydraulic	150mm	710mm	145mm	-	✓	£1,499.95	£1,299.95	£1,559.94
D	PPF301S	30tonne	Floor Standing - Air/Hydraulic	168mm	710mm	145mm	200mm	✓	£1,999.95	£1,599.95	£1,919.94
E	PPF501S	50tonne	Floor Standing - Air/Hydraulic	248mm	930mm	145mm	280mm	✓	£3,199.95	£2,399.95	£2,879.94
F	PPF100S	100tonne	Floor Standing - Air/Hydraulic	324mm	1090mm	300mm	360mm	X	£4,999.95	£3,999.95	£4,799.94

SAFETY GUARDS FOR VIKING HYDRAULIC PRESSES



- Lightweight steel frames with Polycarbonate screens.
- Adjustable guard protects the user and/or passer-by from being injured if workpiece is accidentally dislodged under load.
- Bolts onto either side of the table and features varying height increments, allowing the workpiece to be placed onto table with no obstruction.
- One-way spring loaded locking clips then allow the guard to be pulled up quickly and snap straight into position for full protection.

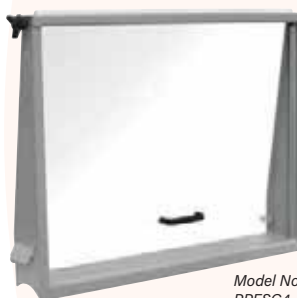

Model No.	Compatibility	List Price	Exc. VAT	Inc. VAT
PPBSG	PPB15S Press	£129.95	£99.95	£119.94
PPFSG1	PPF20S & PPF30S Presses	£159.95	£119.95	£143.94
PPFSG2	PPF301S Press	£169.95	£124.95	£149.94
PPFSG3	PPF501S Press	£179.95	£129.95	£155.94
PPFSG4	PPF100S Press	£319.95	£239.95	£287.94

TRIKE COVERS



- Ideal for protection, rain or shine, against weathering and fading.
- All covers have a clear PVC pocket to accept Model No. SPP01 Solar Panel (requires Model No. SPP01.A Adaptor) to enable battery charging while cover is fitted to the motorcycle without the need for mains power supply.
- Elastic corners with strap and buckle for easy and secure fitting.
- Made from Oxford 300D material.

Model No.	Size	Length	Width (Front/Rear)	Height (Front/Rear)	List Price	Exc. VAT	Inc. VAT
STC03	Small	2500mm	470/1550mm	1250/1400mm	£79.95	£63.95	£76.74
STC02	Medium	2750mm	470/1750mm	1300/1400mm	£84.95	£69.95	£83.94
STC01XL	X-Large	4500mm	450/2000mm	1400/1550mm	£95.95	£74.95	£89.94

10PC MOTORCYCLE FLYWHEEL PULLER SET



- Comprehensive set of flywheel pullers used to separate flywheel from the crankshaft taper.
- Features 10 pullers of which five have double ends, giving increased applications.
- Suitable for most makes of motorcycle.
- Supplied in storage case.
- **Model No. SMC48**
- List Price £64.95

£49.95 Exc. VAT
 £59.94 Inc. VAT

MOTORCYCLE TRANSPORTATION COMBO

Package includes:

- TD284SD - 25mm x 4m Polyester Webbing Ratchet Tie Down with S-Hooks 800kg Breaking Strength
- TDMCHB - Motorcycle Handlebar Tie Down
- TDMCRW - Motorcycle Rear Wheel Tie Down
- WCR02 - Tie Down - Motorcycle Roll-in Wheel Clamp - Bolt Down
- **Model No. MTC01**
- List Price £123.95



£79.95 Exc. VAT
 £95.94 Inc. VAT



500kg Capacity

MOTORCYCLE DOLLY REAR WHEEL SIDE STAND TYPE

- Motorcycle dolly holds a single motorcycle with a side stand (Maximum overall vehicle weight of 500kg).
- Easy to manoeuvre around the workshop or garage.
- Front wheel stays in contact with the ground allowing the motorcycle to be steered into the desired position.
- Pivoting feature allows flexibility in side stand designs.
- Side stand holder can be adjusted to cater to the majority of motorbikes.
- **Model No. MS0630**
- List Price £107.45

£79.95 Exc. VAT
 £95.94 Inc. VAT

12V AUTOMATIC BATTERY CHARGERS & MAINTAINERS

2 YEAR GUARANTEE*

12V

START STOP

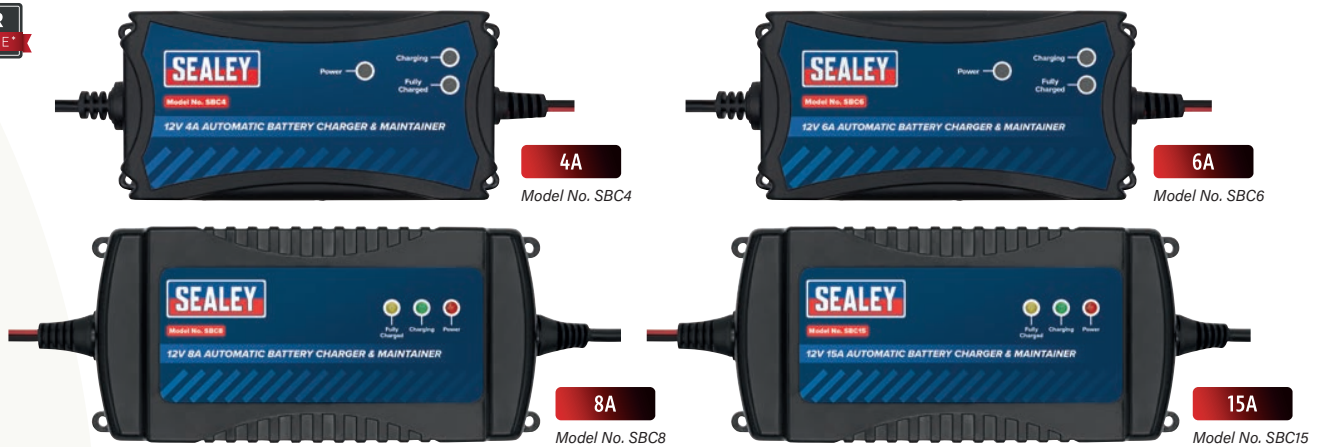

- Fully automatic 12V 3-stage battery chargers, designed for charging and maintaining a variety of EFB & AGM (stop/start), GEL, lead acid and calcium batteries with auto-shut-off maintenance function.
- Zero volt battery charging, enabling recovery and charging of a completely discharged battery (providing any load removed from the rechargeable battery).
- Old battery sulfation repair function.
- Reverse polarity, short circuit, over temperature, over voltage and overcharging protection.
- Easy-to-read LED indicators display power status and charging stages.

Model No.	Peak Output Charge	Battery Range	List Price	Exc. VAT	Inc. VAT
SBC4	4A	40-80Ah	£38.95	£24.95	£29.94
SBC6	6A	40-100Ah	£46.95	£29.95	£35.94
SBC8	8A	40-120Ah	£72.95	£49.95	£59.94
SBC15	15A	40-200Ah	£99.95	£69.95	£83.94

NEW LINES

VEHICLE SERVICE TOOLS

PETROL ENGINE TIMING TOOL KIT FOR FORD, VOLVO 1.6 ECOBOOST & 2.0D/2.2D - BELT DRIVE



BELT



- Includes a time-saving crankshaft pulley alignment tool.
- Camshaft locking tool is included which has to be used to set and lock the camshafts into their timing position when the variable valve timing sprockets have to be removed.
- Timing pins included are suitable for Ford 2.0D/2.2D diesel engines.
- Supplied in a storage case with instructions and a warning tag.
- Model No. VSE6560A**
- List Price £89.95

£63.95 Exc. VAT
£76.74 Inc. VAT

FUEL PUMP LOCKING/REMOVAL TOOL FOR JLR 2.0D INGENIUM ENGINE CHAIN DRIVE



CHAIN



- Designed to lock the fuel pump sprocket and timing chain into position while the pump is removed/replaced.
- Model No. VSE3036**
- List Price £79.95

£59.95 Exc. VAT
£71.94 Inc. VAT

ENGINE TIMING CHECK KIT 1.2 GDI PURETECH FOR PSA BELT DRIVE



BELT

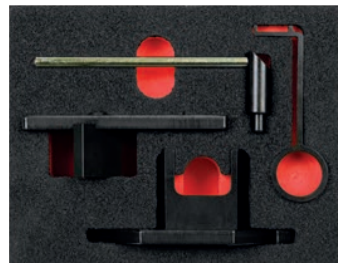

- This kit provides an accurate and time saving method to check the timing belt for deterioration and stretch.
- Belt stretch may lead to incorrect camshaft timing.
- Supplied in a storage foam with full instructions.
- Model No. VS5255**
- List Price £136.95

£109.95 Exc. VAT
£131.94 Inc. VAT

TIMING TOOL KIT FOR JLR 2.0/2.0D INGENIUM ENGINE CHAIN DRIVE



CHAIN

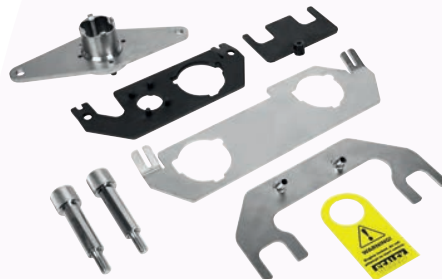

- Includes the special tools required to set the camshaft adjusters.
- Supplied in a storage case with instructions and a warning tag.
- Model No. VSE3037**
- List Price £299.95

£239.95 Exc. VAT
£287.94 Inc. VAT

HIGH PRESSURE FUEL PUMP SPROCKET LOCKING PIN PSA/FORD BELT DRIVE



BELT



- Designed to lock the high pressure fuel pump sprocket to enable the sprocket nut to be removed.
- Facilitates the removal of the high pressure fuel pump.
- Equivalent to OEM 0194-J.
- Use in conjunction with Model No. VSE5846.
- Model No. VS5258**
- List Price £15.95

£10.95 Exc. VAT
£13.14 Inc. VAT

DIESEL ENGINE TIMING TOOL KIT GM 1.3 CDTI CHAIN DRIVE



CHAIN

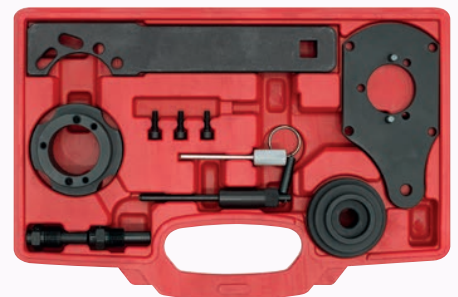

- Contents include crankshaft pulley hub holding tool and camshaft position sensor positioning tool.
- Supplied in a storage case with instructions and a warning tag.
- Model No. VSE5001**
- List Price £134.95

£109.95 Exc. VAT
£131.94 Inc. VAT

A/C & FUEL LINE DISCONNECTION SET



- Automotive fuel line and air conditioning hose disconnection set.
- Suitable for a wide variety of vehicles with quick disconnect couplings.
- Compatible with low profile fuel lines on a range of Ford, Vauxhall/Opel, Mazda and Chrysler.
- Designed for automotive fuel, A/C and transmission cooler lines.
- Made from a tough durable plastic that is resistant to fuel and solvents.
- Offset handles are ideal to access fittings in tight spaces.
- **Model No. VS0555**
- List Price £7.95

£5.75 Exc. VAT
£6.90 Inc. VAT

SMOKE DIAGNOSTIC TOOL LEAK DETECTORS

12V



Model No. VS869

Model No. VS868

- Allows the technician to pinpoint all manner of system leaks including the air intake, cooling, evaporation, fuel, exhaust and vacuum systems.
- Fast and simple-to-use, maximising earning potential.
- System is clean and quick to use and connects to a 12V vehicle battery.
- Supplied with cone adapter, power cord clamp, valve core wrench, test oil refill bottle, smoke hose, EVAP connector, universal airbag adapter, blanking rubber cones.
- Rubber cone sizes: Ø5-10, 9-15, 14-19, 18-26, 25-35, 32-45, 45-60, 60-75mm.
- Mineral oil not included.

Model No.	EVAP	List Price	Exc. VAT	Inc. VAT
VS868	X	£419.95	£299.95	£359.94
VS869	✓	£629.95	£449.95	£539.94

Ø8mm CAMERA VIDEO BORESCOPIES

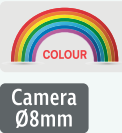

Model No. VS8112

- High performance handheld borescopes with 60mm colour LCD screen and waterproof probe pod with IP67 rating.
- Features video record/playback and still images.
- Videos and images are stored on a micro SD card (not supplied).
- 2.5Ah Lithium battery capacity allowing up to 10 hours working time.
- Kit includes 45° mirror, hook and magnetic pick-up.
- USB Charging cable supplied.

Model No.	Cable Length	List Price	Exc. VAT	Inc. VAT
VS8111	2m	£79.95	£64.95	£77.94
VS8112	10m	£99.95	£79.95	£95.94



Model No. VS8111

Ø8mm WI-FI BORESCOPE

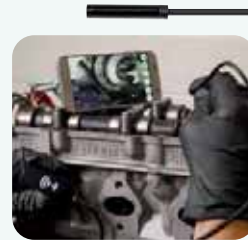

- Application: IOS, Android and Windows.
- Waterproof Level: IP67 (RIBU).
- Camera Head: Ø8mm.
- Camera Lens: 6 x LEDs.
- Resolutions: 640 x 480, 1280 x 720.
- Transmission Distance: 5-30m.
- Cable Length: 5m.
- Record and screen shot.
- Screen rotation function.
- Viewing Angle: 70°.
- Kit Includes charging cable, hook, magnet, and side mirror.
- **Model No. VS8113**
- List Price £44.95

£37.95 Exc. VAT
£45.54 Inc. VAT

TABLET VIDEO BORESCOPIES



- Large 110mm LCD screen with a resolution up to 1080p full HD for video recording, playback and still images.
- Tablet design makes the image incredibly clear but also very portable.
- Features controls for light intensity, digital zoom and image rotation.
- Waterproof probe pod with IP67 rating.
- Powered by 2600mAh rechargeable with 5 hour working time (USB Charging cable supplied).
- SD card can be installed to achieve file storage (not supplied).
- Kit includes 45° mirror, hook and magnetic pick-up.
- Cable Length: 2m.

Model No.	Camera Size	List Price	Exc. VAT	Inc. VAT
VS8114	Ø3.9mm	£119.95	£99.95	£119.94
VS8115	Ø5.5mm	£109.95	£89.95	£107.94
VS8116	Ø8mm	£99.95	£79.95	£95.94



Model No. VS8114

6-24V CIRCUIT TESTER

6V to 24V



- Suitable for 6-24V DC circuits.
- Insulated body with test light.
- Probe tip is covered with protective plastic cap.
- Tester illuminates when voltage is present.
- Supplied with cable and alligator earth clip.
- **Model No. AK5000**
- List Price £9.95

£6.45 Exc. VAT
£7.74 Inc. VAT

BATTERY MONITOR SENSOR & VEHICLE FINDER

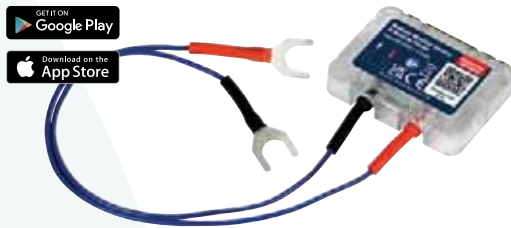

- Displays real time battery power, voltage and temperature.
- Wireless connection with dedicated app which supports up to four devices (IOS & Android compatible).
- Guide user back to the vehicle by automatically recording the last parking location.
- Record the route, cost and driving habits of each trip, which can be exported to Excel.
- Automatically monitor the starting and charging system of the vehicle and notify if abnormal.
- Compatible with most batteries including lead sealed, AGM and Gel.
- Store historical data in device for up to 30 days.
- **Model No. BT2020**
- List Price £29.95

£23.95 Exc. VAT
£28.74 Inc. VAT

25m BLACK/YELLOW POST & CHAIN KIT

- Highly visible post and chain kit ideal for creating a temporary safety barrier when working on hybrid and electric vehicles.
- Consists of six black/yellow posts, six bases, 25m x 6mm black/yellow plastic chain and chain securing hooks.
- Only fill post base with dry sand when working around electricity.
- **Model No. BYSBKIT**
- List Price £159.95



£129.95 Exc. VAT
£155.94 Inc. VAT

HIGH VOLTAGE VEHICLE WARNING SIGN



- High voltage warning sign suitable for use on vehicles.
- Printed on both sides.
- Supplied with two suction cups on the base.
- Size (W x H): 210 x 300mm.
- **Model No. HVSA1**
- List Price £27.95

£19.95 Exc. VAT
£23.94 Inc. VAT

SCAN FOR OUR FULL RANGE OF HYBRID TOOLS



HIGH VOLTAGE MAINTENANCE COMBO

Package includes:

- PPHY - CAT IV 1000V Hybrid Vehicles High Voltage Tester
- RWSBKIT - 25m Red/White Post & Chain Kit
- HVG1000VL - 1kV Electrician's Safety Gloves - Pair
- HVSA4 - 200 x 300mm High Voltage Warning Sign
- HYBRIDSIGN - Hybrid/Electric Vehicle Warning Sign
- HYBRIDTAG - Hybrid/Electric Vehicle Keyring Warning Tag

- **Model No. HVPDCOMBO**
- List Price £359.95

£249.95 Exc. VAT
£299.94 Inc. VAT





EV/HYBRID MASTER TOOL KIT

Package Includes:

- APPD70 - 7 Drawer Push-To-Open Rollcab - Orange
- SF300R (x3) - 1200 x 550 x 30mm Easy Peel Shadow Foam® Orange/Black
- SF500R (x3) - 1200 x 550 x 50mm Easy Peel Shadow Foam® Orange/Black
- PPHY - CAT IV 1000V High Voltage Tester Hybrid/Electric Vehicles
- BYSBKIT - 25m Black/Yellow Post & Chain Kit
- HVG1000VL - 1kV Electrician's Safety Gloves - Pair
- HVM17K02 - Electrician's Insulating Rubber Safety Mat
- TA319 - Digital Insulation Tester
- HVSA4 - 200 x 300mm High Voltage Warning Sign
- HYBRIDTAG - Hybrid/Electric Vehicle Keyring Warning Tag
- HYBRIDSIGN - Hybrid/Electric Vehicle Warning Sign
- AK83452 - 3pc Pliers Set - VDE Approved
- AK6124 - 8pc Screwdriver Set - VDE Approved
- AK63171 - 7pc Insulated Open-End Spanner Set - VDE Approved
- AK7940 - 16pc 3/8" Sq Drive Insulated Socket Set - VDE Approved
- STW803 - 3/8" Sq Drive Calibrated Insulated Torque Wrench 12-60Nm
- AK7177 - 6pc Extra-Long Hex Key Set - VDE Approved
- AK7178 - 9pc Extra-Long TRX-Star* Key Set - VDE Approved
- HRP45 - High Voltage Rescue Pole

- **Model No. HVCOM1**
- List Price £2,699.95

£1,799.95 Exc. VAT
£2,159.94 Inc. VAT

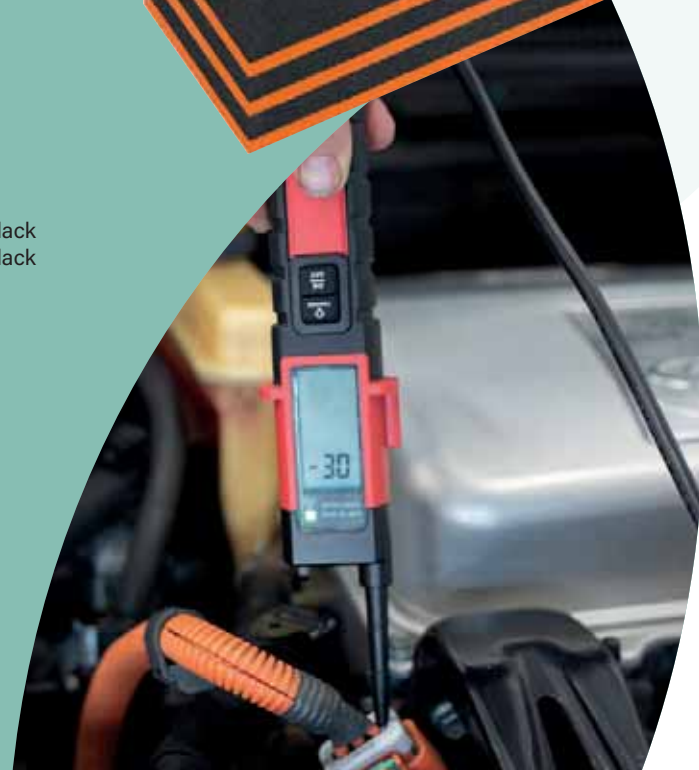

1750W INDUCTION HEATER



12V



- Install appropriate coil and place over or around ferrous metal.
- Ideal for loosening stubborn and seized fixings.
- Supplied with two attachable front coils, flexible coil for a customized fit, a flat coil for heating flat metal and straightening small dents in car bodies and plastic trim/sticker removal.
- Induction element delivers high heat fast and effectively.
- Contents: Direct Coil; Ø20, Ø30mm, Pad Coil; Ø65mm, Flex Coil; 785mm.
- **Model No. VS260**
- List Price £699.95

Specification	
Frequency	50/60Hz
Power	1750W
Input Current	8A
Duty Cycle	1.5mins on/ 1.5mins off
Nett Weight	4.40kg

£549.95 Exc. VAT
£659.94 Inc. VAT

38PC INJECTOR BORE CLEANING BRUSH SET



- Ideal for cleaning and decarbonising areas with limited access, especially injector apertures before refitting.
- 38-Piece set includes brass, steel and nylon brushes 8-19mm.
- Soft grip handle.
- One-Piece 150mm Extension.
- **Model No. VS1910**
- List Price £49.95

£39.95 Exc. VAT
£47.94 Inc. VAT

14PC INJECTOR BORE CLEANING BRUSH SET



- Ideal for cleaning and decarbonising areas with limited access, especially injector apertures before refitting.
- Set includes 3-Piece Brass Brushes 18/20/25mm.
- 2-Piece End Brushes 15/19mm.
- 1-Piece Steel Rod.
- 1-Piece Rod.
- 6-piece blanking plugs.
- **Model No. VS1900**
- List Price £38.95

£26.95 Exc. VAT
£32.34 Inc. VAT

2PC INJECTOR BORE CLEANING BRUSH SET



- Ideal for cleaning and decarbonising areas with limited access, especially injector apertures before refitting.
- Brush Size: 10-34.5mm, 15mm.
- Brush Type: Steel.
- Overall Length: 260mm, 275mm.
- **Model No. VS1920**
- List Price £19.95

£14.95 Exc. VAT
£17.94 Inc. VAT

FOLLOW US ON OUR SOCIALS



SEALEY TOOLS

SUBSCRIBE
 To our Youtube Channel,
 find us by searching "Sealey Tools!"

EMERGENCY BREAKOUT TOOL WITH TYRE TREAD DEPTH GAUGE



- Trigger action and hardened tip shatters glass with minimum effort.
- Designed for 5mm automotive tempered glass.
- **Model No. TST19**
- List Price £9.95

£7.95 Exc. VAT
£9.54 Inc. VAT

40MM PREMIUM EVA KNEELING MATS

Model No. VS8597

40mm

- Premium 40mm shock absorbing EVA kneeling mats.
- Neoprene wipe clean material.
- Suitable for workshop, home and garden.
- Cut-out handle.



Model No.	Size (L x W x D)	List Price	Exc. VAT	Inc. VAT
VS8595	470 x 280 x 40mm	£18.95	£12.95	£15.54
VS8597	800 x 380 x 40mm	£39.95	£29.95	£35.94

7PC HOSE CLIP REMOVAL TOOL SET

- A comprehensive hose clip plier set, features heavy-duty construction with ratchet locking mechanism on most pliers.
- Vinyl dipped handles give additional comfort.



Contents:

- Space saver hose clip plier. Jaw opening 0-70mm.
- Swivel Clic-R® type plier. Jaw opening 0-34mm.
- Multipurpose hose clamp plier. Jaw opening 0-40mm.
- Remote action flexi clamp plier. Jaw opening 3-54mm.
- Hose clamp interchangeable head plier. Jaw opening 0-60mm.
- Hose clamp compressor. Jaw opening 6-68mm. Use with 14mm spanner.
- Ear type CV boot/hose clip plier. Jaw opening 0-20mm.

- **Model No. VS2662**
- List Price £159.95

£114.95 Exc. VAT
£137.94 Inc. VAT



2PC MERCEDES BENZ ENGINE MOUNT SPANNERS 16 & 17MM

- 2-Piece set consisting of 16 and 17mm ring spanners for Mercedes Benz engine mount bolts.
- 12-Point ring spanners with Internal 3/8" Sq drive.
- Ideal for removing engine mount bolts in tight spaces.
- **Model No. VS3005**
- List Price £19.95



£16.45 Exc. VAT
£19.74 Inc. VAT

5PC PANEL WEDGE TOOL SET

- 5-Piece panel wedge removal set.
- For removal of mouldings, door coverings, plastic clips and plugs.
- Set includes a wedge, clip remover, long wedge with taper, thin wedge and wedge with felt padding.
- **Model No. RT05**
- List Price £19.95



£14.95 Exc. VAT
£17.94 Inc. VAT

5PC 80MM 1/2"SQ DRIVE DOUBLE ENDED DEEP IMPACT SOCKET SET

1/2" Sq. Drive **MM** Deep

- Chromium plated caps fitted to some wheel nuts are prone to swelling, making them incompatible with standard whole size sockets.
- Half sizes allow secure fitment for safe removal.
- Double ended 80mm deep impact sockets 1/2" Sq Drive 6-point.
- Sizes: 80mm Sockets; 18.5-19.5, 19-21, 21-21.5, 22-22.5mm, 1/2" Sq Drive Extension; 75mm (3").
- Black phosphate finish.
- **Model No. SX1820**
- List Price £54.95



£39.95 Exc. VAT
£47.94 Inc. VAT

3PC AXLE BEARING PULLER SET

- 3-Piece axle bearing remover set is designed for easy removal of rear axle bearings.
- Use with Sealey slide hammer PS983 or PS992 (sold separately).
- Puller head sizes: 20, 24, 30mm.
- **Model No. VS7033**
- List Price £39.95

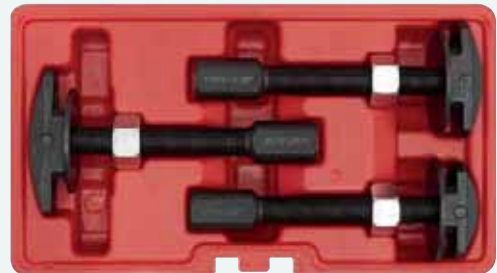

£32.95 Exc. VAT
£39.54 Inc. VAT

PANEL BAG SETS



- Multipurpose durable air cushion devices with rigid edges and fine air control valve.
- Suitable for positioning panels (bonnets + boots) prior to fitment.
- Can be used to improve access for emergency vehicle opening tools.
- Soft air cushion is gentle on paintwork, frame, beadings and glass.
- Can also be used for positioning kitchen units, windows and doors.



Model No.	Qty	Sizes	Min./Max. Thickness	List Price	Exc. VAT	Inc. VAT
VS9111	2pc	115 x 190mm	2-60mm	£14.95	£9.95	£11.94
VS9112	2pc	150 x 165mm	2-70mm	£14.95	£9.95	£11.94
VS9113	2pc	128 x 270mm	2-80mm	£19.95	£13.95	£16.74
VS9114	3pc	115 x 190mm, 150 x 165mm, 128 x 270mm	2-80mm	£24.95	£17.95	£21.54

4PC RATCHET BAR CLAMP SETS



Model No. AK61014

- Set of four action clamp sets with comfort grip handle and quick release button for fast adjustment.
- Operates in compression or expansion.
- Resilient clamping faces.
- 63mm Throat.

Model No.	Length	List Price	Exc. VAT	Inc. VAT
AK61014	150mm	£43.95	£24.95	£29.94
AK61024	300mm	£54.95	£36.95	£44.34

2PC QUICK BAR CLAMP SETS



Model No. QBC3002

- Packs of two heavy-duty bar clamp and spreader fitted with textured TPR grip for improved ergonomics and suitable for one-handed operation.
- Features quick change screw to switch between clamp and spreader functions.
- Full faced pads provide even distribution of pressure.
- Features a maximum clamping force of up to 150kg.
- Fitted with strengthened carbon steel bar minimising bending.

Model No.	Length	List Price	Exc. VAT	Inc. VAT
QBC1502	150mm	£44.95	£34.95	£41.94
QBC3002	300mm	£49.95	£39.95	£47.94

4PC 45MM RATCHET CLAMP SET

- Pack of four quick ratcheting clamps with easy release trigger.
- Free-moving pads enable clamping at multiple angles.
- Features maximum jaw opening of 45mm.
- Model No. RC504
- List Price £26.95



£19.95 Exc. VAT
£23.94 Inc. VAT

5L CONTAINER HAND PUMP



- Hand pump that fits 5L containers with a 38mm screw top.
- Features quick-fit nozzle.
- Mess and waste liquid eliminated.
- Includes a set of three clear hoses; 8, 13.5, 59cm.
- Dispenses 30ml per stroke.
- Model No. TP5000
- List Price £8.95



30ml per stroke

5L

£6.95 Exc. VAT
£8.34 Inc. VAT

4PC ECONOMY FIXED SPOUT SMALL FUNNEL SET

- Polyethylene funnel, small range set suitable for many fluids including oil, antifreeze and windshield wash.
- Ø50mm, Ø75mm, Ø95mm and Ø115mm funnels with hanging tabs.
- Not suitable for acetone, gun wash, thinners or petrol.
- Model No. F92
- List Price £6.95



£3.95 Exc. VAT
£4.74 Inc. VAT

8V CORDLESS GREASE GUN



- Lightweight versatile cordless grease gun, producing 3000psi.
- Suitable for 85g/3oz and 400g/14oz cartridges.
- Supplied with flexi and rigid delivery nozzles as well as a 400g cartridge adaptor.
- Kit contains an 8V 2Ah Lithium-ion battery and mains charger.
- Model No. CPG8V
- List Price £99.95



8V

£79.95 Exc. VAT
£95.94 Inc. VAT

8V 2AH LITHIUM-ION POWER TOOL BATTERY FOR CPG8V

- Battery pack for Model No. CPG8V Cordless Grease Gun 8V.
- 8V 2Ah Lithium-ion.
- Model No. CPG8VBP
- List Price £23.45



8V
RECHARGEABLE

£18.95 Exc. VAT
£22.74 Inc. VAT

ENGINE OIL FUNNEL SETS



Model No. VS7104

AVAILABLE MID-SEPTEMBER

- Fastens and seals into the engine filler with three manufacturer specific adaptors.
- Hands-free operation with no mess or spills.
- For instructions and complete list of vehicle applications, go to sealey.co.uk.

Model No.	Applications	Set Size	List Price	Exc. VAT	Inc. VAT
VS7102	Renault and Nissan	4pc	£47.95	£34.95	£41.94
VS7104	Renault and Nissan	3pc	£35.95	£24.95	£29.94
VS7105	Audi, Seat, Skoda and Volkswagen	5pc	£47.95	£34.95	£41.94
VS7106	BMW and Mercedes-Benz	4pc	£47.95	£34.95	£41.94

2-IN-1 HEAVY-DUTY COMPACT RIVETER

- Suitable for hand and threaded nut rivets in aluminium, steel and stainless steel.
- 11 Nozzles to accept blind rivets up to 6.4mm and rivet nuts up to M10.
- Short arms provide effortless functionality and access to restricted spaces.
- Rivet Nut Sizes: M3 x 0.5, M4 x 0.7, M5 x 0.8, M6 x 1, M8 x 1.25, M10 x 1.5mm.
- Blind Rivet Sizes: 2.4mm(3/32"), 3.2mm(1/8"), 4mm(5/32"), 4.8mm(3/16"), 6.4mm(1/4").
- Supplied with nozzle spanner.
- Comfortable ergonomic grips.
- **Model No. AK3989**
- List Price £99.95

£69.95 Exc. VAT
£83.94 Inc. VAT



LIFETIME
GUARANTEE*

HEAVY
DUTY

SWIVEL HEAD RIVETING KIT

Swivel Head

- Pressed steel body with cast swivel head and Chrome Molybdenum steel jaws.
- Supplied with four rivet nozzles to accept 2.4mm(3/32"), 3.2mm(1/8"), 4mm(5/32") and 4.8mm(3/16") rivets.
- Suitable for aluminium (2.4mm, 3.2mm, 4.0mm, 4.8mm) steel and stainless steel rivets (2.4mm, 3.2mm, 4.0mm).
- Includes a selection of approximately 80 rivets.
- **Model No. AK3991**
- List Price £49.95

£36.95 Exc. VAT
£44.34 Inc. VAT



SWIVEL HEAD 2-IN-1 RIVETER

Swivel Head

- Four nozzles for standard rivets (2.4mm(3/32"), 3.2mm(1/8"), 4mm(5/32") and 4.8mm(3/16").
- Four mandrels for rivet nuts. (M3, M4, M5, M6).
- Pressed steel body with cast swivel head and Chrome Molybdenum steel jaws.
- Supplied with nozzle spanner.
- **Model No. AK3992**
- List Price £74.95

£53.95 Exc. VAT
£64.74 Inc. VAT



DUST-FREE SANDING KIT

35L
Ø50mm
350W
Wet & Dry



- High powered unit for use with power tools.
- Certified for M Class dust extraction in accordance with EU directives, protecting the operator from dust particles.
- Supplied with Electric Palm Sander Ø150mm 350W/230V, 70 x 120mm Sanding Block, 70 x 198mm Sanding Block, Ø36mm flexible hose, crevice nozzle, multi-diameter tool adaptor, inserts for liquid collection and hard floors, cord clamps, M Class bag and cartridge filters and foam filter.
- Set to continuous suction or synchronise with a power tool via a 2000W rated, electronically controlled outlet.
- Fitted with a self-cleaning filter designed to prevent blockages.

Package includes:

- PC35230V - 35L Wet/Dry Vacuum Cleaner Industrial 1200W/230V Plastic Drum.
- DAS150PS - Ø150mm Electric Palm Sander Variable Speed 350W/230V.
- RE4011 - 70 x 120mm Dust-Free Sanding Block.
- RE4012 - 70 x 198mm Dust-Free Sanding Block.

- **Model No. DFSK02**
- List Price £849.95

£649.95 Exc. VAT
£779.94 Inc. VAT

2PC PANEL GAP SETTING TOOL

- Panel gap setting tool with 10 plastic gauges and a suction cup for damage-free mounting and use.
- Each gauge is 1mm thick with alternating colours for easy selection.
- Ideal for use on panels gaps and windscreen mounting to ensure even gaps.
- Range of 1-10mm.
- **Model No. PST01**
- List Price £29.95

£21.95 Exc. VAT
£26.34 Inc. VAT

CONTOUR GAUGE WITH LOCK

- Profile gauge for use when comparing a damaged panel to the original.
- For duplication of profile when preparing bodywork.
- Features lock to secure pins when comparing panel shape.
- Pins made from non-scratch PS plastic.
- Suitable for use on various flooring, tiling and metal work.
- **Model No. SPG01**
- List Price £17.95

£12.95 Exc. VAT
£15.54 Inc. VAT

NEW LINES

AIR TOOLS

2PC HOSE GUIDE SET

- 2-Piece set of hose guides helps stop air hoses, water hoses and electric cables from catching on tyres.
- Can be mounted on a wall so hoses and cables can be stored.
- **Model No. SHG01**
- List Price £9.95



£6.95 Exc. VAT
£8.34 Inc. VAT

**AIR NEEDLE SCALER - PISTOL TYPE**

- Pistol type scaler suitable for cleaning heavy paint and rust scale from metal surfaces.
- Removable needle head allows use as a standard air hammer but requires additional chisel set and spring retainer (not included).
- Features variable speed trigger control.
- Order Model No SA50.02 for Replacement Needle Set.
- **Model No. SA501**
- List Price £44.95

4 cfm **VARIABLE SPEED**



£36.95 Exc. VAT
£44.34 Inc. VAT

MINI AIR BLOW GUN WITH VENTURI TIP

- Composite mini air blow gun with venturi tip for increased airflow compared to standard blow guns.
- Small size and detachable hook allow the blow gun to be ready to use at all times.
- Max. working pressure of 90psi.
- **Model No. SA904**
- List Price £9.95



£7.95 Exc. VAT
£9.54 Inc. VAT



Air Supply Ring Main System



Install your own workshop compressed air ring main quickly, easily and competitively with these compressed air systems. A complete professional compressed air system can be installed quickly and easily, considerably reducing the need for specialist staff. Avoids extensive disruption and downtime. Simple push-action pipe fittings do away with preparing threaded tubes or applying solvents. Complex pipe and fitting configurations are also assembled more rapidly since the fittings can be disassembled and reconfigured quickly. Both our Speedfit® and Sharkbite® ranges of compressed air systems are fully compatible with each other and can be connected to existing ring main even if made of galvanized steel.



For illustration purposes only.

Lightweight yet strong acetel copolymer fittings and nylon pipe runs.



For illustration purposes only.

Brass fittings and aluminium pipe.

- ✓ Quick to install - save up to 40% in time and cost.
- ✓ Corrosion resistant and maintenance-free.
- ✓ Safe, secure and leak-proof.
- ✓ Simple to reconfigure.
- ✓ Easy to handle.

SCAN TO VIEW
THE FULL
RANGE



Kits available in
SharkBite® or
JG Speedfit®

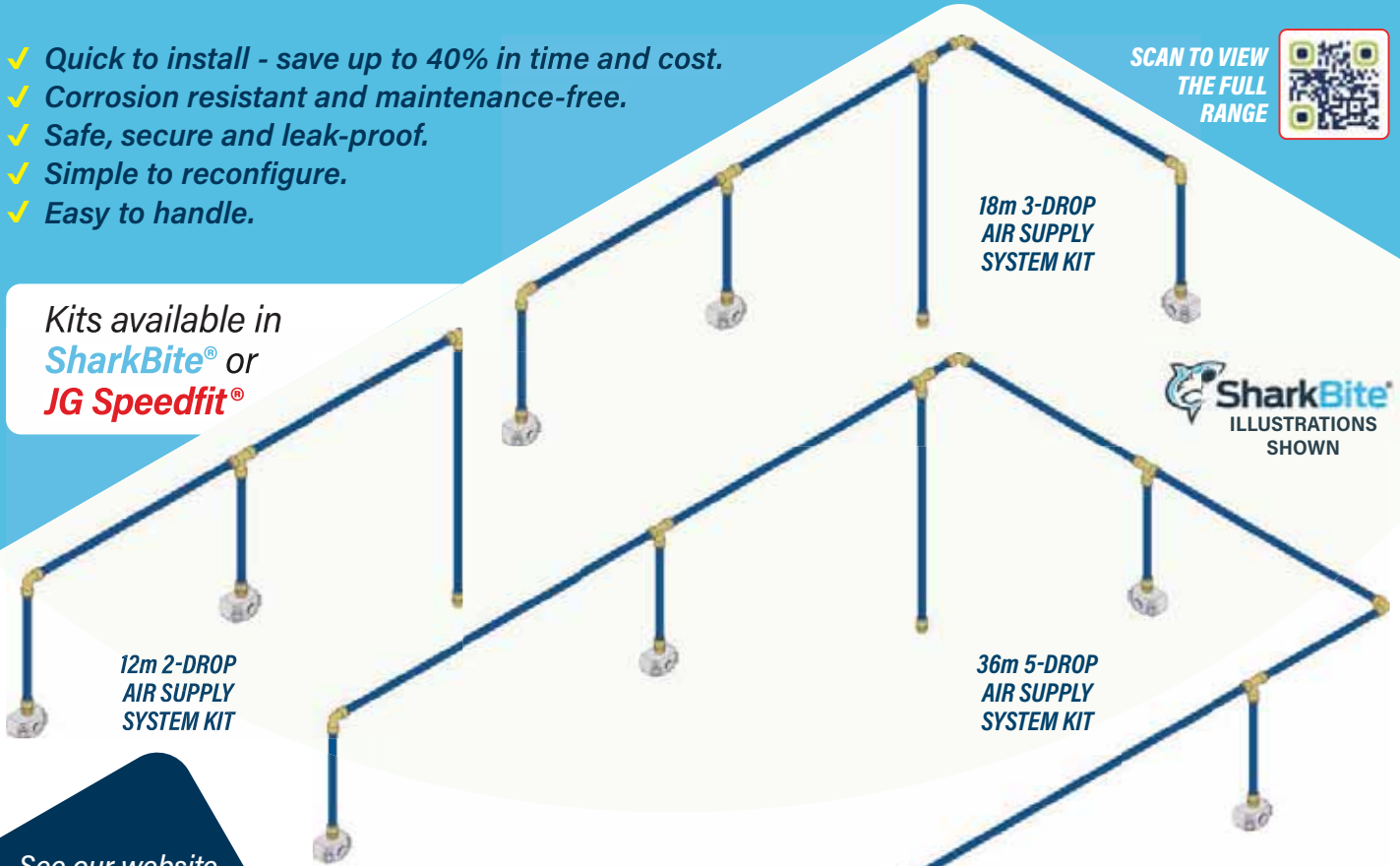

12m 2-DROP
AIR SUPPLY
SYSTEM KIT

18m 3-DROP
AIR SUPPLY
SYSTEM KIT

36m 5-DROP
AIR SUPPLY
SYSTEM KIT



See our website,
www.sealey.co.uk
for full kit details.



22mm Speedfit® Air Supply System Kits					
Model No.	Drops	Length	List Price	Exc. VAT	Inc. VAT
CASKIT2	2	12m	£249.95	£169.95	£203.94
CASKIT3	3	18m	£379.95	£279.95	£335.94
CASKIT5	5	36m	£679.95	£499.95	£599.94



22mm SharkBite® Air Supply System Kits					
Model No.	Drops	Length	List Price	Exc. VAT	Inc. VAT
SBAKIT2	2	12m	£469.95	£299.95	£359.94
SBAKIT3	3	18m	£699.95	£499.95	£599.94
SBAKIT5	5	36m	£1,199.95	£879.95	£1,055.94

Inside SharkBite® Technology

SharkBite® push-fit fittings use grip and seal technology. The stainless steel grab ring grips the pipe and the O-Ring provides an airtight seal.

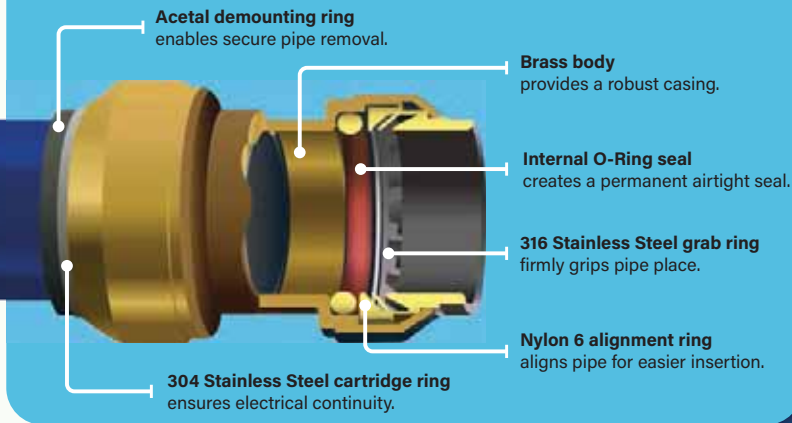

Wall Boxes				
Model No.	Thread	List Price	Exc. VAT	Inc. VAT
CAS12WB	1/2"	£53.95	£44.95	£53.94
CAS34WB	3/4"	£53.95	£44.95	£53.94

3m Anodised Aluminium Pipes				
Model No.	Pipe OD	List Price	Exc. VAT	Inc. VAT
SBA15AP	Ø15mm	£27.95	£22.95	£27.54
SBA22AP	Ø22mm	£51.95	£42.95	£51.54
SBA28AP	Ø28mm	£69.95	£57.95	£69.54

Disconnect Clip & Depth Gauges				
Model No.	Pipe OD	List Price	Exc. VAT	Inc. VAT
SBA15DC	Ø15mm	£2.45	£2.15	£2.58
SBA22DC	Ø22mm	£2.95	£2.65	£3.18
SBA28DC	Ø28mm	£3.45	£2.95	£3.54

Ball Valves				
Model No.	Pipe OD	List Price	Exc. VAT	Inc. VAT
SBA15BV	Ø15mm	£31.95	£16.45	£19.74
SBA22BV	Ø22mm	£44.95	£22.95	£27.54
SBA28BV	Ø28mm	£66.95	£54.95	£65.94

Equal Elbows				
Model No.	Pipe OD	List Price	Exc. VAT	Inc. VAT
SBA15EE	Ø15mm	£19.95	£16.45	£19.74
SBA22EE	Ø22mm	£28.95	£23.95	£28.74
SBA28EE	Ø28mm	£32.95	£26.95	£32.34

Equal Tees				
Model No.	Pipe OD	List Price	Exc. VAT	Inc. VAT
SBA15ET	Ø15mm	£20.95	£16.95	£20.34
SBA22ET	Ø22mm	£29.95	£24.95	£29.94
SBA28ET	Ø28mm	£39.95	£32.95	£39.54

Line End Plugs				
Model No.	Pipe OD	List Price	Exc. VAT	Inc. VAT
SBA15P	Ø15mm	£6.95	£5.75	£6.90
SBA22P	Ø22mm	£8.95	£7.45	£8.94
SBA28P	Ø28mm	£13.95	£11.45	£13.74

Pipe Clips - Packs of 10				
Model No.	Pipe OD	List Price	Exc. VAT	Inc. VAT
SBA15PC	15mm	£15.95	£12.95	£15.54
SBA22PC	22mm	£29.95	£18.95	£22.74
SBA28PC	28mm	£35.95	£13.95	£16.74

Straight Connectors				
Model No.	Pipe OD	List Price	Exc. VAT	Inc. VAT
SBA15SC	Ø15mm	£18.95	£15.45	£18.54
SBA22SC	Ø22mm	£25.95	£21.45	£25.74
SBA28SC	Ø28mm	£38.95	£31.95	£38.34

Reducing Couplings				
Model No.	Pipe Reduction	List Price	Exc. VAT	Inc. VAT
SBA2215	Ø22mm down to Ø15mm	£33.95	£27.95	£33.54
SBA2822	Ø28mm down to Ø22mm	£42.95	£34.95	£41.94

Brass Straight Adaptor				
Model No.	Pipe OD	List Price	Exc. VAT	Inc. VAT
SBA15BSA	15mm x 1/2"BSPT	£29.95	£23.95	£28.74
SBA22BSA	Ø22mm x 3/4"BSPT	£33.95	£27.95	£33.54
SBA28BSA	Ø28mm x 1"BSPT	£43.95	£35.95	£43.14

Reducing Tees				
Model No.	Pipe Reduction	List Price	Exc. VAT	Inc. VAT
SBA2215T	Ø22mm down to Ø15mm	£29.95	£24.95	£29.94
SBA2822T	Ø28mm down to Ø22mm	£37.95	£29.95	£35.94

Brass Wingback Elbows				
Model No.	Pipe OD	List Price	Exc. VAT	Inc. VAT
SBA15BWE	Ø15mm x 1/2"BSPT	£37.95	£29.95	£35.94
SBA22BWE	Ø22mm x 3/4"BSPT	£62.95	£51.95	£62.34

MMA INVERTER WELDERS

140A 160A 180A OR 200A

- Lightweight, powerful and incredibly versatile, inverters offer many advantages over traditional transformer type welders.
- Inverters use state-of-the-art electronic components to produce fully portable power sources for arc welding.
- For example, Model No. MW160i will produce up to 160A at 20% duty cycle; a conventional 160A welder would have a duty cycle of around 10%.
- Manufactured from pressed steel with a powder coated finish for extra corrosion resistance, with ergonomically designed composite end for a stylish design and keeping weight below 7kg.
- Features a carry handle, ideal for mobile technicians.

Premier

3 YEAR
GUARANTEE*



Model No. MW200i



Model No.	Welding Current	Duty Cycle	Electrode Capacity	List Price	Exc. VAT	Inc. VAT
MW140i	20-140A	100% @ 63A, 60% @ 81A, 20% @ 140A	Ø1.6-3.2mm	£199.95	£164.95	£197.94
MW160i	20-160A	100% @ 72A, 60% @ 92A, 20% @ 160A	Ø1.6-4mm	£229.95	£189.95	£227.94
MW180i	20-180A	100% @ 80A, 60% @ 104A, 20% @ 180A	Ø1.6-4mm	£259.95	£209.95	£251.94
MW200i	20-200A	100% @ 89A, 60% @ 115A, 20% @ 200A	Ø1.6-5mm	£289.95	£239.95	£287.94

Model No. MW200i



Model No. MW140i

Model No. MW160i



MINI MMA INVERTER WELDERS

120A 140A OR 160A

SCAN FOR OUR FULL RANGE OF INVERTER WELDERS AND ACCESSORIES.



All Models supplied with adjustable shoulder strap.



Model No. MINIMW160i



Model No. MINIMW120i

Model No. MINIMW140i



- Ultra compact and lightweight range of MMA inverter welders, weighing approximately 4kg.
- Portability allows the welder to be taken to the job at hand, ideal for the mobile technicians and enthusiasts.
- These units can ARC/MMA weld a variety of rods including rutile, basic and stainless from Ø1.6mm up to Ø4mm*.
- Features LED display, with thermal cut-out protection, anti-stick, arc force & hot start functions.
- Supplied with 1.6m 12 or 16mm² cable* with electrode holder and a 1.4m 12 or 16mm² earth clamp and cable*, both with 10-25 dinse connectors.
- Forced air cooling system.

Model No.	Welding Current	Duty Cycle	Electrode Capacity	List Price	Exc. VAT	Inc. VAT
MINIMW120i	20-120A	100% @ 93A, 60% @ 120A	Ø1.6-3.2mm	£89.95	£73.95	£88.74
MINIMW140i	20-140A	100% @ 108A, 60% @ 140A	Ø1.6-3.2mm	£99.95	£79.95	£95.94
MINIMW160i	20-160A	100% @ 124A, 60% @ 160A	Ø1.6-4mm	£114.95	£94.95	£113.94

*Refer to specific models for diameter of rods and cables.

SV10.8
SERIES

The SV10.8 Series, powered by fast charging 2Ah or 4Ah Lithium-ion batteries, has been designed to make everyday tasks quick and easy. These quality, stylish tools, ideal for light-duty tasks, feature ergonomic housings with soft grip, making them comfortable and easy-to-use.



10.8V 2AH SV10.8 SERIES Ø85mm CORDLESS CIRCULAR SAW KIT

Ø85mm



Model No. CP108VCS



- Supplied with 1 x wrench for removing and replacing blades.
- No-Load Speed: 0-1450rpm.

Model No. CP108VCS kit includes:

- CP108VCSBO - 10.8V SV10.8 Series Ø85mm Cordless Circular Saw - Body Only
- CP108VBP - 10.8V 2Ah SV10.8 Series Lithium-ion Battery Pack
- CP108VMC - 10.8V SV10.8 Series Fast Charge Lithium-ion Battery Charger

Model No.	Type	List Price	Exc. VAT	Inc. VAT
CP108VCS	Kit	£99.95	£79.95	£95.94
CP108VCSBO	Body Only	£67.95	£53.95	£64.74

10.8V 2AH SV10.8 SERIES CORDLESS RECIPROCATING SAW KIT

- 20mm Stroke length.
- Built-in quick blade change system and safety guard.
- Supplied with single cutting blade - order Model No. WRS3021/150 for pack of five replacement blades.
- Locking button for added security.



Model No. CP108VRS



Model No. CP108VRS kit includes:

- CP108VRSBO - 10.8V SV10.8 Series Cordless Reciprocating Saw - Body Only
- CP108VBP - 10.8V 2Ah SV10.8 Series Lithium-ion Power Tool Battery
- CP108VMC - 10.8V SV10.8 Series Lithium-ion Battery Charger

Model No.	Type	List Price	Exc. VAT	Inc. VAT
CP108VRS	Kit	£84.95	£67.95	£81.54
CP108VRSBO	Body Only	£51.95	£39.95	£47.94

10.8V 2AH SV10.8 SERIES Ø85mm CORDLESS ANGLE GRINDER KIT



- Variable speed with six settings.
- Adjustable blade guard and spindle locking button.
- Supplied with 1 x hex key for easy blade switching.
- Disc Size: Ø85mm.
- Free Speed: 12000rpm/19500rpm.



Model No. CP108VAG



Model No. CP108VAG kit includes:

- CP108VAGBO - 10.8V SV10.8 Series Ø85mm Cordless Angle Grinder - Body Only
- CP108VBP - 10.8V 2Ah SV10.8 Series Lithium-ion Battery Pack
- CP108VMC - 10.8V SV10.8 Series Lithium-ion Battery Charger

Model No.	Type	List Price	Exc. VAT	Inc. VAT
CP108VAG	Kit	£86.95	£69.95	£83.94
CP108VAGBO	Body Only	£53.95	£42.95	£51.54

10.8V 2AH SV10.8 SERIES CORDLESS MULTIPURPOSE MINI GRINDER KIT

- Quick release collet and spindle lock for fast tool changes.
- Supplied with a 50-piece range of tips, wheels, discs, dressing stones and a chuck spanner.



Model No. CP108VMG



Model No. CP108VMG kit includes:

- CP108VMGBO - 10.8V SV10.8 Series Cordless Multipurpose Mini Grinder & 50pc Accessory Kit - Body Only
- CP108VBP - 10.8V 2Ah SV10.8 Series Lithium-ion Battery Pack
- CP108VMC - 10.8V SV10.8 Series Fast Charge Lithium-ion Battery Charger

Model No.	Type	List Price	Exc. VAT	Inc. VAT
CP108VMG	Kit	£56.95	£44.95	£53.94
CP108VMGBO	Body Only	£23.95	£18.95	£22.74

4A 12V LITHIUM-ION FAST CHARGE BATTERY CHARGER FOR SV12 SERIES



- 4A For faster recharging of the SV12 Series.
- Compatible with battery pack Model No's CP1200BP and CP1200BP4.
- **Model No. CP1200MC4A**
- List Price £31.95

£24.95 Exc. VAT
£29.94 Inc. VAT



SV12
SERIES

The SV12 Series offers a range of compact and lightweight tools, ideal for use in tight spaces. Ergonomic composite housings reduce vibration, providing operator comfort.



SV20 SERIES

The SV20 Series offers quality, stylish, lightweight tools designed with composite housing and a soft grip, making them comfortable and easy-to-use. Highly suited to heavy-duty tasks, these tools deliver powerful outputs without compromising on operating time. The series provides a choice of three Lithium-ion batteries ranging from 2Ah, for a faster charge, up to 6Ah for a longer lasting runtime. Available as body only or kits containing Batteries, Charger and Storage Bag.



20V SV20 SERIES TELESCOPIC CORDLESS HEDGE TRIMMER & CHAINSAW KITS

- 1 CP20VTP - 20V SV20 Series Cordless Telescopic Pole for CP20VPSH/CP20VPHT
- 2 CP20VPHT - 20V SV20 Series Cordless Pole Hedge Trimmer - Body Only
- 3 CP20VPSH - 20V SV20 Series 20cm Cordless Chainsaw Head - Body Only
- 4 CP20VBP2 - 20V 2Ah SV20 Series Lithium-ion Power Tool Battery
- 5 CP20VBP4 - 20V 4Ah SV20 Series Lithium-ion Power Tool Battery
- 6 CP20VMC - 20V SV20 Series Lithium-ion Battery Charger



Model No. **A**
CP20VTPCOMBO



B

Model No.
CP20VTP01



C

Model No.
CP20VTP02

Ref.	Model No.	Type (Model No's Included)	Batteries in Kit	List Price	Exc. VAT	Inc. VAT
A	CP20VTPCOMBO	Complete Kit (1-6)	1 x 2Ah, 1 x 4Ah	£339.95	£214.95	£257.94
B	CP20VTP01	Hedge Trimmer Kit (1, 2, 4 & 6)	1 x 2Ah	£199.95	£139.95	£167.94
C	CP20VTP02	Chainsaw Kit (1, 3, 5 & 6)	1 x 4Ah	£239.95	£169.95	£203.94
-	CP20VTP	Telescopic Pole - Body Only (1)	-	£74.95	£59.95	£71.94
-	CP20VPHT	Hedge Trimmer - Body Only (2)	-	£79.95	£63.95	£76.74
-	CP20VPSH	Chainsaw Head - Body Only (3)	-	£89.95	£71.95	£86.34

20V SV20 SERIES 15L CORDLESS GARDEN BACKPACK SPRAYER KITS

15L

- 15L water tank with a lance holder clip.
- Water flow: 1.3L/min.
- Max Pressure: 1.6bar.
- Spraying lance including hose is 2.53m.
- Used for sterilization, disinfection, weed killing, as well as watering flowers and spraying water.
- Does not require manual pressing which makes it easy and practical to use.
- Supplied with three different nozzles to meet different needs and an auto-cut-off function.
- Strong durable back straps to ensure comfort when worn.
- Added filter to prevent larger particles clogging the machine.
- Kits are supplied with mains charger and canvas storage bag.



Model No.
CP20VGBSKIT1

STORAGE BAG INCLUDED



Model No.	Type	Batteries in Kit	List Price	Exc. VAT	Inc. VAT
CP20VGBSKIT1	Kit	1 x 2Ah	£199.95	£134.95	£161.94
CP20VGBSKIT	Kit	1 x 2Ah, 1 x 4Ah	£271.95	£184.95	£221.94
CP20VGBS	Body Only	-	£119.95	£95.95	£115.14

20V SV20 SERIES CORDLESS PRESSURE WASHER KITS

- 6-Function nozzles.
- 120L/hr Flow rate and a working pressure of 22bar.
- Ideal for cleaning muddy bikes and sports equipment, as well as gutters, conservatory roofs and other hard-to-reach places.
- 6m Water intake hose with float and filter can draw water from any remote source.
- Kits are supplied with mains charger and canvas storage bag.



Model No.
CP20VPWKIT1

STORAGE BAG INCLUDED



Model No.	Type	Batteries in Kit	List Price	Exc. VAT	Inc. VAT
CP20VPWKIT1	Kit	1 x 2Ah	£189.95	£124.95	£149.94
CP20VPWKIT	Kit	1 x 2Ah, 1 x 4Ah	£261.95	£174.95	£209.94
CP20VPW	Body Only	-	£109.95	£84.95	£101.94

20V 2AH SV20 SERIES CORDLESS PRUNING SHEARS KITS



- Brushless motor, which gives an improved performance and requires less maintenance than the brushed equivalent, giving you a more efficient, longer lasting tool.
- Cuts through branches up to Ø25mm.
- Additional safety switch for extra protection.
- Power assisted pruning shears makes pruning stems and branches quick and easy.
- Ergonomic and lightweight in design.
- Kits are supplied with mains charger and canvas storage bag.



Model No.
CP20VPSKIT1

STORAGE BAG INCLUDED



Model No.	Type	Batteries in Kit	List Price	Exc. VAT	Inc. VAT
CP20VPSKIT1	Kit	1 x 2Ah	£214.95	£144.95	£173.94
CP20VPSKIT	Kit	2 x 2Ah	£256.45	£174.95	£209.94
CP20VPS	Body Only	-	£134.95	£107.95	£129.54

20V 4AH SV20 SERIES 25CM CORDLESS CHAINSAW KITS

- Features high quality Oregon bar and chain.
- Bar Length: 25cm.
- Chain Pitch: 3/8".
- Chain Speed: 6m/s.
- Kick back protection with instant chain brake.
- Tool-less chain tensioning and changing.
- Automatic chain lubrication and oil level indication display.
- Oil Tank Capacity: 110ml.
- Kits are supplied with mains charger and canvas storage bag.



Model No.
CP20VCHSKIT1

STORAGE BAG INCLUDED



Model No.	Type	Batteries in Kit	List Price	Exc. VAT	Inc. VAT
CP20VCHSKIT1	Kit	1 x 4Ah	£239.95	£164.95	£197.94
CP20VCHSKIT	Kit	2 x 4Ah	£309.95	£214.95	£257.94
CP20VCHS	Body Only	-	£129.95	£107.95	£129.54

20V SV20 SERIES CORDLESS 3-IN-1 GARDEN TOOL KITS

- Ergonomic design and lock-in function make it comfortable and easy to use.
- Three tool-less interchangeable functions.
- Grass shearing blade cutting width 90mm.
- Hedge trimmer blade for light trimming, cutting length 200mm.
- Raker length 100mm.
- Kits are supplied with mains charger and canvas storage bag.



Model No.
CP20VGT3KIT1

STORAGE BAG INCLUDED



Model No.	Type	Batteries in Kit	List Price	Exc. VAT	Inc. VAT
CP20VGT3KIT1	Kit	1 x 2Ah	£129.95	£87.95	£105.54
CP20VGT3KIT	Kit	1 x 2Ah, 1 x 4Ah	£201.95	£134.95	£161.94
CP20VGT3	Body Only	-	£49.95	£39.95	£47.94

230V/20V SV20 SERIES 16" 2-IN-1 CORDLESS/CORDED HIGH VELOCITY DRUM FAN KIT



Model No. HVD16CCOMBO

- Lightweight, portable and robust unit fitted with rubber feet.
- Handle and 360° tilting stand allowing control of airflow.
- Carefully balanced and fully guarded aluminium blades provide quiet and safe operation.
- Kit is supplied with mains charger.

Model No.	Type	Batteries in Kit	List Price	Exc. VAT	Inc. VAT
HVD16CCOMBO	Kit	1 x 6Ah	£293.95	£189.95	£227.94
HVD16C	Body Only	-	£179.95	£114.95	£137.94

30,000-68,000BTU/HR (9-20KW) SV20 SERIES 2-IN-1 CORDLESS/CORDED SPACE WARMER[®] PROPANE HEATER KIT



PROPANE



Model No. LP69CCOMBO

- 30,000-68,000Btu/hr(9-20kW) Variable output.
- Features safety solenoid.
- Fan assisted, fitted with a piezoelectric ignition system for trouble-free starting and features a direct gas head assembly.
- Kit is supplied with mains charger.

Model No.	Type	Batteries in Kit	List Price	Exc. VAT	Inc. VAT
LP69CCOMBO	Kit	1 x 4Ah	£293.95	£199.95	£239.94
LP69C	Body Only	-	£199.95	£149.95	£179.94

20V SV20 SERIES 2-IN-1 CORDLESS/CORDED SMD LED 4000LM WORKLIGHT KIT

SMD LED

UP TO 4000 LUMENS

STORAGE BAG INCLUDED

Model No. CP20VWLKIT1



- 360° Movement.
- 96 SMD LED Lights producing up to 4000 lumens.
- Robust design with integrated carry handle and side lights to illuminate the darkest spaces.
- Simple on/off switch with two levels of brightness depending on power supply.
- Kit is supplied with mains charger and canvas storage bag.

Model No.	Type	Batteries in Kit	List Price	Exc. VAT	Inc. VAT
CP20VWLKIT1	Kit	1 x 4Ah	£179.95	£114.95	£137.94
CP20VWL	Body Only	-	£69.95	£57.95	£69.54

20V SV20 SERIES CORDLESS SMD LED 1800LM WORKLIGHT KIT

SMD LED

1800 LUMENS

STORAGE BAG INCLUDED

Model No. CP20VCLKIT1



- 360° Lightweight cordless clip worklight.
- 70 SMD LED 6500K Lights.
- 1800lm With four levels of brightness.
- IP20 Rated.
- Kit is supplied with mains charger and canvas storage bag.

Model No.	Type	Batteries in Kit	List Price	Exc. VAT	Inc. VAT
CP20VCLKIT1	Kit	1 x 4Ah	£157.95	£99.95	£119.94
CP20VCL	Body Only	-	£47.95	£37.95	£45.54

20V SV20 SERIES 3/8" SQ DRIVE CORDLESS RATCHET WRENCH KITS

3/8" Sq. Drive

60Nm Torque

VARIABLE SPEED

STORAGE BAG INCLUDED



Model No. CP20VRWKIT1

- Maximum Torque: 60Nm.
- No-Load Speed: 0-250rpm.
- Variable speed trigger for easy control.
- Forward and reverse rotation.
- Trigger-lock button.
- Fitted with electronic brake.
- Built-in LED work light for low visibility areas.
- Kits are supplied with mains charger and canvas storage bag.

Model No.	Type	Batteries in Kit	List Price	Exc. VAT	Inc. VAT
CP20VRWKIT1	Kit	1 x 4Ah	£189.95	£124.95	£149.94
CP20VRWKIT	Kit	2 x 4Ah	£259.95	£179.95	£215.94
CP20VRW	Body Only	-	£79.95	£63.95	£76.74

20V SV20 SERIES CORDLESS 310ML CAULKING GUN KITS

VARIABLE SPEED

STORAGE BAG INCLUDED



Model No. CP20VCGKIT1

- 6-Speed variable setting.
- Flow rate from 0.7-11m/s.
- Max dispensing force: 4500N.
- Suitable for 310ml cartridges.
- Composite housing with soft grip for added comfort.
- Kits are supplied with mains charger and canvas storage bag.

AVAILABLE MID-SEPTEMBER

Model No.	Type	Batteries in Kit	List Price	Exc. VAT	Inc. VAT
CP20VCGKIT1	Kit	1 x 2Ah	£199.95	£134.95	£161.94
CP20VCGKIT	Kit	1 x 2Ah, 1 x 4Ah	£271.95	£184.95	£221.94
CP20VCG	Body Only	-	£119.95	£95.95	£115.14

20V SV20 SERIES 650ML CORDLESS HANDHELD VACUUM CLEANER KITS

100W

- Features soft comfortable grip and is convenient for use in the home, workshop or car.
- Removable collection chamber with easy release button to dispose of waste efficiently.
- Supplied with 4-piece accessory pack: extension pipe, crevice nozzle, brush nozzle and floor brush with removable brush section.
- Kits are supplied with mains charger and canvas storage bag.



Model No. CP20VCKIT1

STORAGE BAG INCLUDED



Model No. CP20VCVCF
Replacement Cloth Filter Cartridge

Model No.	Type	Batteries in Kit	List Price	Exc. VAT	Inc. VAT
CP20VCKIT1	Kit	1 x 2Ah	£133.95	£89.95	£107.94
CP20VCKIT	Kit	1 x 2Ah, 1 x 4Ah	£205.95	£139.95	£167.94
CP20VCV	Body Only	-	£53.95	£42.95	£51.54
CP20VCVCF	Replacement Cloth Filter Cartridge	-	£6.95	£5.45	£6.54

20V SV20 SERIES 15L HANDHELD ASH VACUUM CLEANER KITS

15L

- 150W motor provides great suction performance whilst also acting as a blower.
- A 1m flexible metal lined suction hose allows the suction of ash up to a temperature of 40°C(100°F).
- Easily switch to blow function by using the outlet on the top of the vacuum.
- Includes a HEPA filter with inner metal mesh preventing the leaking of ash and dust and round aluminium nozzle.
- Kits are supplied with mains charger and canvas storage bag.



STORAGE BAG INCLUDED

Model No. CP20VAVKIT1



Model No. CP20VAVF
Replacement HEPA Filter Cartridge

Model No.	Type	Batteries in Kit	List Price	Exc. VAT	Inc. VAT
CP20VAVKIT1	Kit	1 x 2Ah	£144.95	£94.95	£113.94
CP20VAVKIT	Kit	1 x 2Ah, 1 x 4Ah	£216.95	£144.95	£173.94
CP20VAV	Body Only	-	£64.95	£49.95	£59.94
CP20VAVF	Replacement HEPA Filter Cartridge	-	£9.95	£7.95	£9.54

20V 4AH SV20 SERIES BRUSHLESS RECIPROCATING SAW KITS

- Brushless motor gives superior performance and durability.
- Suitable for cutting wood, board and soft metals.
- No-load speed 0-3100spm.
- Stroke length: 28mm.
- Variable speed trigger switch.
- 2-Stage operation switch for added safety.
- Keyless blade change system.
- LED work light.
- Durable composite housing with soft grip for added comfort.
- Kits are supplied with mains charger and canvas storage bag.

VARIABLE SPEED



Model No. CP20VRSXKIT1

STORAGE BAG INCLUDED

Model No.	Type	Batteries in Kit	List Price	Exc. VAT	Inc. VAT
CP20VRSXKIT1	Kit	1 x 4Ah	£259.95	£169.95	£203.94
CP20VRSXKIT	Kit	2 x 4Ah	£329.95	£219.95	£263.94
CP20VRSX	Body Only	-	£149.95	£115.95	£139.14



Scan for our full range of Reciprocating Saw Blades.

20V 4AH SV20 SERIES Ø180MM BRUSHLESS ROTARY POLISHER KITS

Ø180mm

VARIABLE SPEED

- Brushless motor gives superior performance and durability.
- Ø180mm backing pad.
- 6-Speed settings.
- No-load speed: 800-2300rpm.
- Thread size: M14.
- Variable speed trigger with lock.
- Two handle positions - up and over or on the side.
- Supplied with two interchangeable polishing pad heads and key for quick backing pad changes.
- Kits are supplied with mains charger and canvas storage bag.



Model No. CP20VRPXKIT1

STORAGE BAG INCLUDED

Model No.	Type	Batteries in Kit	List Price	Exc. VAT	Inc. VAT
CP20VRPXKIT1	Kit	1 x 4Ah	£269.95	£156.95	£188.34
CP20VRPXKIT	Kit	2 x 4Ah	£339.95	£174.95	£209.94
CP20VRPX	Body Only	-	£159.95	£119.95	£143.94



Part of the SV20 Series, our brushless motor tools give an improved performance and require less maintenance than the brushed equivalent, giving you a more efficient, longer lasting tool.



3 YEAR GUARANTEE



35PC DRILL & BIT ACCESSORY SET



- Manufactured to DIN 3126 specification.
- Contents: Drill Bits; HSS Coated - Ø1.5, 2, 3, 4, 5, 6mm. Masonry - Ø3, 4, 5, 6, 7, 8mm, Wood - Ø3, 4, 5, 6, 7, 8mm Bits; Slotted - 4, 5, 6mm, Phillips - #1, #2, #3, Pozi - #1, #2, #3, TRX-Star* - T20, T25, T30, Magnetic Nut Holders; 6, 8, 10mm, Stainless Steel Bit Holder, Countersink Bit.

• **Model No. AK3735**

• List Price £19.95

£15.95 Exc. VAT

£19.14 Inc. VAT

3PC HINGE DRILL SET



- Spring-loaded sleeve has a chamfered tip to position centrally in hole.
- Replace worn drill bits by undoing hex head screw on side.
- Contents: Hinge Drill Bits; 7/64" x 87mm, 9/64" x 89mm, 11/64" x 98mm, 2.5mm hex key.
- 1/4" Hex shank.
- **Model No. AK3HD**
- List Price £13.95

£10.95 Exc. VAT

£13.14 Inc. VAT

Ø88 x 20mm UNIVERSAL STRIPE REMOVING PAD



- Suitable for removing pin stripes or double-sided tape from panel work prior to refinishing.
- Waved design to increase airflow and thus prolonging life.
- 5/16" UNF Fitting with 6mm mandrel adaptor to also allow use with a standard drill.

• **Model No. SA95UNI**

• List Price £13.95

£9.95 Exc. VAT

£11.94 Inc. VAT

18PC WOOD/MASONRY DRILL BIT SET



- Set consists of nine bradpoint drills and nine tungsten steel masonry drills.
- Sizes: Masonry; Ø3, 3, 4, 4, 5, 5, 6, 8, 10mm, Wood; Ø3, 3, 4, 4, 5, 5, 6, 8, 10mm.
- Supplied in plastic storage box with rubberised, non-slip coating.
- **Model No. AK3718MW**
- List Price £15.95

£11.95 Exc. VAT

£14.34 Inc. VAT

EXTRA-WIDE CHISELS



WORKSAFE
SEALEY

Model No. 71EWC

Model No.	Size	List Price	Exc. VAT	Inc. VAT
71EWC	125 x 475mm 7/8" Hex	£51.95	£34.95	£41.94
1E1EWC	110 x 608mm 1-1/8" Hex	£83.95	£56.95	£68.34

80GRIT ASSORTED SANDING SLEEVES PACK OF 5



- 80Grit Sanding Sleeves Ø13 x 90mm, Ø19 x 90mm, Ø25 x 90mm, Ø38 x 90mm, Ø50 x 90mm.
- Suitable for use with Model No. SM1300.
- **Model No. SS5ASS**
- List Price £13.45

£8.95 Exc. VAT

£10.74 Inc. VAT

Ø115 x 6mm GRINDING DISCS Ø22mm BORE PACK OF 12



- Aluminium oxide, depressed centre disc for electric and air tools.
- **Model No. PTC115G12**
- List Price £19.95

£13.95 Exc. VAT

£16.74 Inc. VAT

METAL CUTTING DISCS



Model No. PTC115CET100
Available October.



Model No. PTC115CET50

- General-purpose, flat cutting discs recommended for use with Sealey and other leading makes of grinding and cutting power tools.

Model No.	Size	Bore	Qty	List Price	Exc. VAT	Inc. VAT
PTC/3C100	Ø75 x 2mm	Ø10mm	100	£125.95	£82.95	£99.54
PTC/3C1100	Ø75 x 1.2mm	Ø10mm	100	£111.95	£74.95	£89.94
PTC/100C50	Ø100 x 3mm	Ø16mm	50	£107.95	£69.95	£83.94
PTC/100CT50	Ø100 x 1.6mm	Ø16mm	50	£48.95	£31.95	£38.34
PTC/115C50	Ø115 x 3mm	Ø22mm	50	£64.95	£41.95	£50.34
PTC/115CET100	Ø115 x 1.2mm	Ø22mm	100	£103.95	£67.95	£81.54
PTC/115CT50	Ø115 x 1.6mm	Ø22mm	50	£59.95	£36.95	£44.34
PTC115CET50	Ø115 x 1.2mm	Ø22mm	50	£52.95	£37.95	£45.54

MULTI-TOOL BLADES - CERAMIC



• Blades suitable for cutting ceramic.

Ref.	Model No.	Cutting Length	List Price	Exc. VAT	Inc. VAT
A	SMTA35TC	35mm	£6.95	£4.95	£5.94
B	SMTA50TC	50mm	£2.95	£2.15	£2.58
C	SMTA60TC	60mm	£7.95	£5.75	£6.90
D	SMTA65TC	65mm	£6.45	£4.65	£5.58
E	SMTA78TC	78mm	£6.75	£4.85	£5.82
F	SMTA94TC	94mm	£6.95	£4.95	£5.94

MULTI-TOOL BLADES - WOOD



• HCS blades suitable for cutting wood.

Ref.	Model No.	Cutting Length	Teeth	List Price	Exc. VAT	Inc. VAT
G	SMTA34W	34mm	1.4mm	£2.75	£1.95	£2.34
H	SMTA41W	41mm	1.7mm	£2.95	£2.15	£2.58
I	SMTA65W	65mm	1.4mm	£3.75	£2.75	£3.30
J	SMTA87W	87mm	-	£4.25	£2.95	£3.54

MULTI-TOOL BLADES - METAL & WOOD



• Blades suitable for cutting soft metals and wood.

Ref.	Model No.	Cutting Length	Teeth	List Price	Exc. VAT	Inc. VAT
K	SMTA33MW	33mm	1.4mm	£3.95	£2.85	£3.42
L	SMTA44MW	44mm	1.4mm	£4.45	£3.15	£3.78
M	SMTA80MW	80mm	1.25mm	£6.45	£4.65	£5.58

MULTI-TOOL FAST CUTTING BLADES - WOOD



• HCS blades suitable for cutting wood.
• Larger 2.5mm teeth pitch allows for faster cutting.

Ref.	Model No.	Cutting length	List Price	Exc. VAT	Inc. VAT
N	SMTA34FCW	34mm	£3.75	£2.75	£3.30
O	SMTA65FCW	65mm	£4.65	£3.25	£3.90

AIR SAW BLADES PACKS OF 15

• HSS Air saw blades suitable for Sealey and other leading makes of air saw.

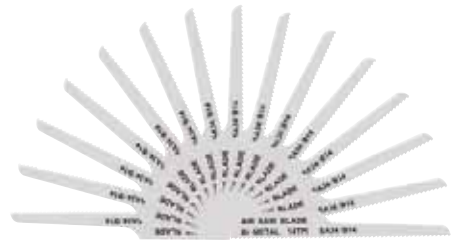

Model No.	Teeth	List Price	Exc. VAT	Inc. VAT
SA34/B1415	14tpi	£28.95	£22.95	£27.54
SA34/B2415	24tpi	£28.95	£22.95	£27.54
SA34/B3215	32tpi	£28.95	£22.95	£27.54
SA34MIX	14tpi (x3), 24tpi (x9), 32tpi (x3)	£28.95	£22.95	£27.54

AIR SAW BLADES PACKS OF 15

• HSS Air saw blades suitable for use with Sealey Model No. SA345 and other leading makes of air saw.



Model No.	Teeth	List Price	Exc. VAT	Inc. VAT
SA345/B1815	18tpi	£29.95	£23.95	£28.74
SA345/B2415	24tpi	£29.95	£23.95	£28.74
SA345/B3215	32tpi	£29.95	£23.95	£28.74
SA345MIX	18tpi (x5), 24tpi (x5), 32tpi (x5)	£29.95	£23.95	£28.74

AIR SAW BLADES

• HSS Air saw blades suitable for use with Sealey Model No. SA346 and other leading makes of air saw.

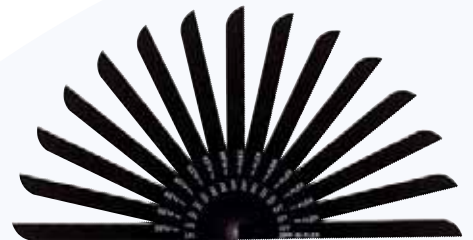

Model No.	Teeth	Qty	List Price	Exc. VAT	Inc. VAT
SA346/B1815	18tpi	15	£34.95	£26.95	£32.34
SA346/B2415	24tpi	15	£34.95	£26.95	£32.34
SA346/B32	32tpi	5	£13.95	£11.45	£13.74
SA346/B3215	32tpi	15	£34.95	£26.95	£32.34
SA346MIX	18tpi (x5), 24tpi (x5), 32tpi (x5)		£34.95	£26.95	£32.34

POLISHER PAD KITS



• Contents: Green Foam (x2), Blue Foam (x2), Orange Foam (x2), Red Foam (x2), Microfibre Pad (x2), Wool Pad (x2).
• Colour guide is as follows: Green is firm and for heavy cutting, blue is medium density all-purpose foam, orange is for polishing, red is soft foam for a final finish, microfibre is slightly more aggressive than foam but is also a finishing pad.

Model No.	Pad Diameter	List Price	Exc. VAT	Inc. VAT
SPK600ACC1	Ø40mm	£13.95	£11.45	£13.74
SPK600ACC2	Ø56mm	£19.95	£16.45	£19.74

5W COB & 3W LED BULB HEAD TORCH WITH AUTO-SENSOR

COB LED

Lithium RECHARGEABLE

350 LUMENS



- COB Lumen Output: 350lm. LED Bulb Output: 120lm.
- Features auto-sensor which is activated by pressing the sensor button next to the power button.
- Operating Time: 2hr @ 100%, 6hr @ 30%.
- Powered by rechargeable Li-Polymer 3.7V 1.2Ah battery.
- **Model No. HT104R**
- List Price £24.95

£20.95 Exc. VAT
£25.14 Inc. VAT

3W COB & 1W SMD LED RECHARGEABLE HEADLIGHT WITH SENSOR

COB LED

SMD LED

Lithium RECHARGEABLE

300 LUMENS



- 3W COB + 1W SMD Rechargeable headlight with sensor function.
- Also including three SMD LEDs producing 300 Lumens.
- Can also act as a separate mini worklight with magnet.
- 3.7V 1000mAh Li-Poly battery with 0.3m USB cable included.
- 4hr Maximum runtime using COB.
- **Model No. HT300R**
- List Price £26.95

£19.95 Exc. VAT
£23.94 Inc. VAT

5W COB & 3W SMD LED RECHARGEABLE 3-IN-1 INSPECTION LIGHT

COB LED SMD LED

- 5W COB LED Directional light.
- 3W SMD LED front torch.
- 3W COB LED front strip including strobe effect.
- Also featuring 180° rotational stand, magnet, hook and clip.
- Supplied with Micro USB charging lead.
- Maximum of 300 lumens and 7hr run time.
- Li-ion battery with charge indicator.
- **Model No. LED316**
- List Price £21.95



300 LUMENS

£17.95 Exc. VAT
£21.54 Inc. VAT

2.5W SMD LED RECHARGEABLE HEAD TORCH



- Hands-free 2.5W SMD LED head torch to direct light as required.
- Two power settings - high/low power with an output of 250/150lm.
- Green LED charge indicator.
- Extendable arms with foam pads for added comfort.
- Push-button mode activation (high/low/off).
- Operating time (high/low): 2/3.5hr.
- Charging time up to 3.5hr.
- Colour temperature 6000-6500k.
- **Model No. HT301R**
- List Price £23.95

£17.95 Exc. VAT
£21.54 Inc. VAT

5W COB & 3W SMD LED RECHARGEABLE UV PENLIGHT WITH LASER POINTER

COB LED

SMD LED

Lithium RECHARGEABLE

- 4-in-1 Worklight, torch, laser and UV light.
- Water and impact resistant aluminium construction.
- 3.7V Li-ion 800mAh rechargeable battery with USB Type-C charge port (supplied).
- Features 5W COB LED, 450lm work light (2.5hr runtime) and 3W SMD LED 140lm torch (2.5hr runtime).
- 365nm Ultraviolet light (4hr runtime) for broad range of applications in commercial and healthcare settings.
- Class 3R red laser (runtime >20hrs) for pointing.
- **Model No. LED450UV**
- List Price £24.95



£19.95 Exc. VAT
£23.94 Inc. VAT

3W SMD LED RECHARGEABLE BULB

SMD LED

Lithium RECHARGEABLE

170 LUMENS



- Operates 14 SMD LEDs that feature five selectable light settings.
- Features 3.7V 1.2Ah Li-ion rechargeable battery for up to 3 hours operating time on its highest setting.
- Produces up to 170 lumens.
- Built-in hanging hook.
- Lumen Output: High/Med/Low; 170/80/40lm.
- **Model No. LED3WB**
- List Price £9.95



£7.95 Exc. VAT
£9.54 Inc. VAT

2 COB & 1 SMD LED RECHARGEABLE ALUMINIUM FOLDING POCKET LIGHT

COB LED

SMD LED

Lithium RECHARGEABLE

800 LUMENS



- Durable aluminium housing.
- Inspection arm can be folded 180°.
- Super bright COB and SMD LED, 6500k.
- Rechargeable high quality 3.7V 2600mAh Lithium-ion battery.
- LED Indicators - flashes green for charging and continuous green for full charge.
- High-impact IK07 Rated.
- Strong magnet on base of handle for hands-free use.
- Charges via a USB Type-C lead (Supplied).
- Charging Time: 4hr.
- Operating Time: Top Spotlight; (120lm) (8hr), Front Light; (800/150lm) (2.5hr/8hr), Rear Light; (400/120lm) (4/9hr).
- **Model No. LED02G**
- List Price £49.95

£34.95 Exc. VAT
£41.94 Inc. VAT

1W SMD LED PENLIGHT 9-IN-1 MULTI-TOOL

SMD LED



- Produces bright white light from single 1W SMD LED.
- Sliding action light focus can be adjusted from spotlight to wide area.
- Strobe light function for emergencies.
- Multi-tool function includes Phillips screwdriver, slotted screwdriver, bottle opener, whistle, ball pen and safety hammer.
- Powered by 3 x LR44 batteries (included).
- **Model No. LED091**
- List Price £11.95

£7.95 Exc. VAT
£9.54 Inc. VAT

3W COB LED ALUMINIUM MINI HAND TORCH

COB LED

Lithium RECHARGEABLE



Magnetic 500 LUMENS

- Side-mounted push-button to switch between two brightness settings of 100 or 300 lumens.
- Press and hold button for 500 lumens super beam.
- Features a magnet on the end, along with a metal belt clip on the back for hands-free operation.
- Battery: 3.7V, 600mAh Li-ion.
- Charging Time: 2.5hr.
- Operating Time (High/Low): 1.5h/3hr.
- Micro USB charging port.
- **Model No. LED500SB**
- List Price £21.45

£15.95 Exc. VAT
£19.14 Inc. VAT

COB & SMD LED INSPECTION LIGHTS
WIRELESS RECHARGEABLE



Model No. LEDWC03

250 LUMENS

Model No. LEDWC04

500 LUMENS

- Fully versatile inspection lights with dimming function.
- Supplied with one strong magnet on the base and two on the back.
- The top spotlight acts as a torch at 100lm.
- Supplied with Type-C USB cable.
- Compatible with Model No's WCB3 and WCB4 Wireless Charging Bases, sold separately.

Model No.	Lumen Output Side/Top	Operating Time Side/Top	Charging Time	List Price	Exc. VAT	Inc. VAT
LEDWC03	15-250lm/100lm	3hr/6hr	4hr	£39.95	£29.95	£35.94
LEDWC04	15-500lm/100lm	2.5hr/10hr	4.5hr	£44.95	£32.95	£39.54

WIRELESS CHARGING BASES



Model No. WCB3

Model No. WCB4

- Wireless charging bases fitted with two strong magnets for attaching to a metal surface.
- Two recessed locking slots on the back for permanent fixture to non-metallic surface or wall.
- Charges both Model No's LEDWC03 and LEDWC04 Wireless Rechargeable Inspection Lights.
- Supplied with Type-C USB charging cable.
- Wireless charging pads are not compatible with other wireless devices/smart phones etc.



Model No. WCB4

Model No.	Type	Input Voltage	List Price	Exc. VAT	Inc. VAT
WCB3	Single	5V→1A	£22.95	£14.95	£17.94
WCB4	Double	5V→2A	£29.95	£19.95	£23.94

COB LED INSPECTION LIGHTS & WIRELESS CHARGING BASES



Model No. LEDWCBCOMBO1

Model No. LEDWCBCOMBO3

Model No. LEDWCBCOMBO2

Model No. LEDWCBCOMBO4

Model No. LEDWCBCOMBO5

Model No.	Contents	List Price	Exc. VAT	Inc. VAT
LEDWCBCOMBO1	LEDWC03 - 3W & 1W COB LED Inspection Light - Wireless Rechargeable WCB3 - 5V→1A Single Wireless Charging Base	£59.95	£42.95	£51.54
LEDWCBCOMBO2	LEDWC04 - 5W & 1W COB LED Inspection Light - Wireless Rechargeable WCB3 - 5V→1A Single Wireless Charging Base	£64.95	£44.95	£53.94
LEDWCBCOMBO3	LEDWC03 - 3W & 1W COB LED Inspection Light - Wireless Rechargeable (x2) WCB4 - 5V→2A Double Wireless Charging Base	£104.95	£74.95	£89.94
LEDWCBCOMBO4	LEDWC03 - 3W & 1W COB LED Inspection Light - Wireless Rechargeable LEDWC04 - 5W & 1W COB LED Inspection Light - Wireless Rechargeable WCB4 - 5V→2A Double Wireless Charging Base	£109.95	£79.95	£95.94
LEDWCBCOMBO5	LEDWC04 - 5W & 1W COB LED Inspection Light - Wireless Rechargeable (x2) WCB4 - 5V→2A Double Wireless Charging Base	£114.95	£82.95	£99.54

15W COB RECHARGEABLE WORK LIGHT



1000 LUMENS

Magnetic

360°

360° Rotation.



- 360° rotatable LED light capable of producing up to 1000 Lumens.
- Includes a hanging hook and a strong magnet for multiple applications.
- Built-in rechargeable 2000mAh lithium-ion battery.
- Power level indicator.
- Emergency power bank function.
- Supplied with Micro USB cable for input/output charging.
- Run time of 3hrs.
- Charging time of 3-4hrs.

• Model No. LED315
• List Price £19.95
£15.95 Exc. VAT
£19.14 Inc. VAT

30W SMD LED LOADING BAY FLOODLIGHT

30W SMD LED

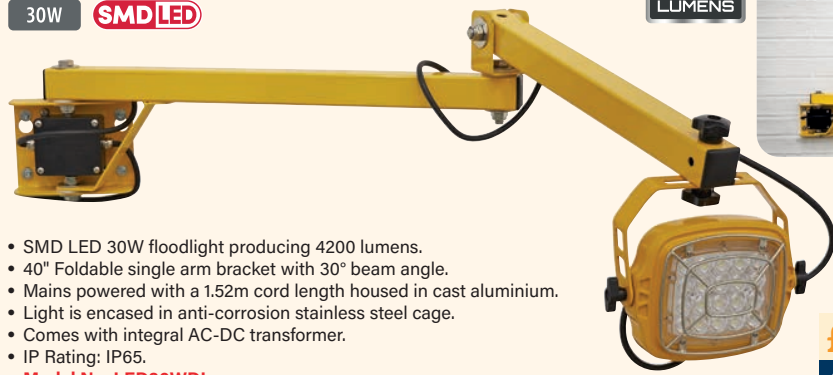

4200 LUMENS



- SMD LED 30W floodlight producing 4200 lumens.
- 40" Foldable single arm bracket with 30° beam angle.
- Mains powered with a 1.52m cord length housed in cast aluminium.
- Light is encased in anti-corrosion stainless steel cage.
- Comes with integral AC-DC transformer.
- IP Rating: IP65.
- **Model No. LED30WDL**
- List Price £199.95

AVAILABLE MID-SEPTEMBER

£169.95 Exc. VAT
£203.94 Inc. VAT

3W SMD LED RECHARGEABLE 3-IN-1 SPOTLIGHT

SMD LED

Li-ion RECHARGEABLE

180 LUMENS

360°



- Rechargeable 3W SMD LED 105 Lumen Spotlight.
- SMD LED 60 Lumen Lantern.
- Lantern produces 360° lighting with two settings.
- SMD LED Desk Lamp producing 180 lumens.
- Desk Lamp has two settings with adjustable lighting angle.
- Slide switch and quick release button to change the light function.
- 3.7V 1500mAh Li-ion battery.
- **Model No. LED140**
- List Price £21.95

£16.95 Exc. VAT
£20.34 Inc. VAT

16W SMD LED EXTRA-SLIM SOLAR FLOODLIGHT WITH WALL BRACKET

16W SMD LED Solar Powered

Li-ion RECHARGEABLE 1600 LUMENS

- 14 SMD LED producing 1600 lumens.
- Features both daylight (CIR) and motion (PIR) sensors to switch on automatically.
- Motion sensor can detect up to 5m.
- Mounted in die-cast powder coated aluminium extra-slim housing with wall bracket.
- 3.7V Li-ion battery with a 3000mAh capacity.
- Run time of 10 hours and has a 30 seconds timer upon sensing motion.
- **Model No. LED16S**
- List Price £29.95



£23.95 Exc. VAT
£28.74 Inc. VAT

12V/24V SMD LED WARNING BEACONS

SMD LED 12V/24V



- Green colour beacon for use on plant vehicles to indicate that a seatbelt is being worn.
- Red colour beacon to be used in recoveries on normal and smart motorways.
- Fitted with high power SMD LEDs.
- 120 Flash per minute pattern.
- Fully meets ECE R10 regulations.
- IP Rating of IP66.



Ref.	Model No.	Colour	Fixing	List Price	Exc. VAT	Inc. VAT
A	WB951LEDG	Green	12mm Bolt	£49.95	£39.95	£47.94
B	WB951LEDR	Red	12mm Bolt	£49.95	£39.95	£47.94
C	WB952LEDR	Red	3 x 6.5mm Bolt	£49.95	£39.95	£47.94
D	WB954LEDR	Red	Magnetic	£49.95	£39.95	£47.94
E	WB955LEDG	Green	Flexible Spigot	£49.95	£39.95	£47.94

10W PORTABLE POWER BANKS

10W



Model No. SPB102



Phone not included.

- Includes built-in Li-ion battery and battery level indicator.
- Suitable for both Micro USB and Type-C input cables (Type-C Cable not included).
- Supplied with Micro USB Charging cable.

Model No.	Capacity	List Price	Exc. VAT	Inc. VAT
SPB101	10000mAh	£19.95	£16.45	£19.74
SPB102	20000mAh	£31.95	£26.95	£32.34

13W SMD LED RECHARGEABLE UNDER-BONNET LIGHT

SMD LED

Li-ion RECHARGEABLE

1200 LUMENS



- Rechargeable Under-Bonnet 1200 Lumen SMD LED worklight with three brightness settings.
- 180° Swivel handle for adjustable lighting angle.
- Each end has a 360° swivel/hanging hook and a magnet.
- 3.7V 4400mAh Li-ion battery.
- 1.8m USB charging cable.
- Includes LED charge indicator.
- Max. 4hr run time.
- **Model No. LED139**
- List Price £57.95

£46.95 Exc. VAT
£56.34 Inc. VAT

110V 10KVA SINGLE PHASE SITE TRANSFORMER

110V

- Site transformer produces a max. output of 10kVA and is designed to be used with a single phase 230V supply.
- Features 4 x 16A socket outlets for individual 110V products and 2 x 32A outlets for heavy/larger site electrical machines.
- Max. rating 10,000VA, continuous rating 7000VA, duty cycle 5min on/30min off.
- Thermal cut-out to prevent system from overheating.
- Class H GRP insulated case rated IP44.
- Centre tapped earth for extra safety.
- **Model No. WST10000**
- List Price £539.95



£499.95 Exc. VAT
£599.94 Inc. VAT

6 DRAWER TOPCHEST & ROLL CAB COMBINATIONS WITH BALL-BEARING SLIDES



- The economical way to buy American PRO® Ball-Bearing quality tool chests.
- This mid-size combo has smooth 25mm ball-bearing slides and all the features of the professional chests except that the rollcab is not lockable and the castors are Ø75mm.
- Overall Sizes (W x D x H): Topchest - 612 x 260 x 340mm, Rollcab - 615 x 295 x 700mm.
- Not interchangeable with the rest of the American PRO® Range.
- **Model No. AP22R - Red**
- **Model No. AP22O - Orange**
- **Model No. AP22HVG - Hi-Vis Green**
- **Model No. AP22B - Blue**
- **Model No. AP22BK - Black**
- **Model No. AP22Y - Yellow**
- List Price £229.95

£189.95 Exc. VAT
£227.94 Inc. VAT

4 DRAWER ROLL CAB WITH 3 DRAWER UTILITY SEAT



- Constructed from heavy gauged steel with steel inner walls for extra strength and durability.
- Heavy-duty 45mm ball-bearing drawer slides provide superior performance and carry heavier loads.
- Fitted with Ø125mm castors with black chrome hubcaps, two swivel locking castors and two fixed.
- Rollcab design features two lockable side cabinets with pegboard and storage tray in each.
- Rust and solvent resistant tough industrial powder coat paint finish.
- Supplied with two keys for main rollcab and two keys for utility seat.
- Overall Size (inc. castors): 679 x 461 x 986mm.
- **Model No. AP556CSHV**
- List Price £749.95



£599.95 Exc. VAT
£719.94 Inc. VAT

4-LEVEL MULTIPURPOSE TROLLEY FOR DIAGNOSTICS



- Multipurpose trolley with four shelves.
- Tough industrial powder coated finish.
- Four open shelves with 10mm EVA liner on top shelf.
- Lockable compartment supplied with two keys.
- Two front steering swivel castors and two rear fixed wheels.
- Supplied with side tray and paper towel holder.
- Side pegboard panels which work with the Sealey TTS range of hooks.
- Compact in design.
- Size (W x D x H): 435 x 522 x 1178mm.
- **Model No. APDT435**
- List Price £449.95



£349.95 Exc. VAT
£419.94 Inc. VAT

450mm 8 POWER TOOL RACK TROLLEY



- 450mm Workshop trolley capable of holding eight power tools.
- Heavy gauged steel construction.
- Rust and solvent resistant black crinkle effect finish.
- Two drawers, one lockable.
- Drawers come with 45mm soft close ball-bearing slides and 2mm EVA liners.
- 18mm Pressed wood top.
- Two steering swivel castors with quick release toe locks and two fixed castors.
- Size (W x D x H) 450 x 600 x 855mm.
- **Model No. APPTR8**
- List Price £499.95



£389.95 Exc. VAT
£467.94 Inc. VAT

MAGNETIC CABLE TIE HOLDERS

Magnetic

- Attaches to any ferrous surface.
- Three compartments for varying lengths of cable ties.
- Three magnetic fixings with rubber pads to prevent slipping.
- **Model No. APCTH - Red**
- **Model No. APCTHHV - Hi-Vis Green**
- List Price £26.95

£21.95 Exc. VAT
£26.34 Inc. VAT

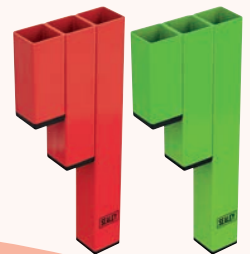

10 DRAWER MOBILE WORKSTATION WITH BACKBOARD



10 Drawer

- 20mm thick wooden worktop.
- 10 Drawers, with a 40kg capacity, feature non-slip liners and aluminium pull handles.
- Six large castor wheels (four fixed and two swivel) that include brakes.
- Pegboard back panel compatible with Sealey TTS range of hooks.
- 14 Storage Bins: Small (x10) and Large (x4).
- Heavy-duty side handle for comfort and control when manoeuvring.
- Overall Size Inc. Handle (W x D x H): 1690 x 490 x 1432mm.
- **Model No. AP6310**
- List Price £1,199.95

£949.95 Exc. VAT
£1,139.94 Inc. VAT



This item is heavy. Extra assistance must be provided at the delivery point to help its safe delivery.

Model No. APMSSTACK17SS

Model No. APMSSTACK17W



SUPERLINE PRO® 4.9m STORAGE SYSTEMS

- Modular design to enable easy upgrading.
- Tough and durable construction with a hammered metal finish on the doors and drawers.
- Aluminium handles and drawer pulls.
- Ball-bearing slides throughout.
- Choice of worktop - pressed wood or stainless steel.
- Gas struts on wall cabinet doors or simple tambour front.
- Floor cabinets feature adjustable shelves.



Package includes:

- APMS56 - Modular Floor Cabinet 2 Door Full Height 915mm
- APMS54 - Modular Wall Cabinet Tambour Front 680mm (x2)
- APMS53 - Modular Wall Cabinet 680mm (x3)
- APMS59 - Modular 5 Drawer Cabinet 680mm
- APMS52 - Modular 2 Door Floor Cabinet 680mm
- APMS58 - Modular 5 Drawer Mobile Cabinet 650mm
- APMS51 - Modular 4 Drawer Cabinet 680mm
- APMS55 - Modular Floor Cabinet Full Height 600mm
- APMS67 - Modular Sink Unit 680mm
- APMS50BP - Modular Back Panel 615mm (x5)
- APMS50UCD - Modular System Upright Connector Double (x4)
- APMS50UCS - Modular System Upright Connector Single (x2)

STAINLESS STEEL WORKTOP



PRESSED WOOD WORKTOP



- Model No. APMSSTACK17SS
- List Price £4,899.95

£3,199.95 Exc. VAT
£3,839.94 Inc. VAT

- Model No. APMSSTACK17W
- List Price £4,789.95

£3,149.95 Exc. VAT
£3,779.94 Inc. VAT

With your choice of worktop...

- APMS50SSC - Stainless Steel Worktop 2040mm
- APMS50SSA - Stainless Steel Worktop 680mm

OR

- APMS50WC - Pressed Wood Worktop 2040mm
- APMS50WA - Pressed Wood Worktop 680mm

Try Our New Workshop Designer

Using our handy design tool, you can bring your workspace to life by creating the perfect combination of drawers, cabinets and back panels.



1360mm MODULAR WALL CABINET



- Use as part of a complete garage storage system or as an individual storage unit.
- Supplied with appropriate fixings to make integral self-supporting unit or use in conjunction with Model No. APMS50BP Back Panel and upright supports if part of a larger modular system.
- Lift-up door is supported by gas struts.
- Aluminium drawer pulls.
- Overall Size (W x D x H): 1360 x 280 x 350mm.
- Model No. APMS68
- List Price £239.95

£199.95 Exc. VAT
£239.94 Inc. VAT



SEE PAGE 42
For Storage System Accessories

680mm MODULAR SINK UNIT



- Use as part of a complete garage storage system or as an individual unit.
- Includes a brushed aluminium mono block mixer tap and matching soap dispenser.
- Large basin with basket strainer waste catcher - (W x D x H): 630 x 350 x 203mm.
- Supplied with flexible hot and cold-water tap connectors, service valves, plus a waste trap.
- Lockable cabinet with high quality lock and two keys.
- Large space underneath to allow for extra storage - (W x D x H): 680 x 430 x 600mm.
- Unit is supplied fully assembled, however tap, soap dispenser and any connection to mains water will need to be completed by a professional.
- Model No. APMS67
- List Price £849.95

£679.95 Exc. VAT
£815.94 Inc. VAT

Model No. APMSCOMBO7SS

Model No. APMSCOMBO7W

STAINLESS STEEL WORKTOP



- Model No. **APMSCOMBO7SS**
- List Price £4,699.95

£3,399.95 Exc. VAT
£4,079.94 Inc. VAT

PRESSED WOOD WORKTOP



- Model No. **APMSCOMBO7W**
- List Price £4,499.95

£3,199.95 Exc. VAT
£3,839.94 Inc. VAT



PREMIER 3.3m STORAGE SYSTEMS

- Modular design to enable easy upgrading.
- Durable powder coated finish.
- Stylish aluminium drawer pulls and handles.
- Precision ball-bearing drawer slides with load capacity of up to 68kg.
- Concealed snap-close magnets on doors.
- Choice of worktops; 25mm Stainless Steel or Pressed Wood complement the cabinet appearance and give a rugged work surface.
- Gas struts on wall cabinet doors.
- Adjustable feet to ensure cabinets sit 'true' even on floors that are not level.
- Floor cabinets are supplied with adjustable height shelves.
- Each unit supplied with high quality cylinder locks and two keys where applicable.

Package Includes:

- APMS21 - Heavy-Duty Modular Full Height Floor Cabinet 2108mm (x2)
- APMS13 - Heavy-Duty Modular Wall Cabinet 775mm
- APMS14 - Heavy-Duty Modular Wall Cabinet 1550mm
- APMS01 - Heavy-Duty Modular Floor Cabinet 775mm
- APMS04 - Heavy-Duty 11 Drawer Modular Floor Cabinet 1550mm
- APMS10 - Modular Back Panel 775mm
- APMS11 - Modular Back Panel 1550mm

With your choice of worktop...

- APMS08 - Stainless Steel Worktop 775mm
- APMS09 - Stainless Steel Worktop 1550mm
- OR
- APMS06 - Pressed Wood Worktop 775mm
- APMS07 - Pressed Wood Worktop 1550mm



1830mm HEAVY-DUTY STEEL ADJUSTABLE WORKBENCHES

- Manufactured from heavy gauge powder-coated steel and is at the top end of our range with a weight capacity of 1000kg (evenly distributed).
- Adjustable leg extensions allow worktop height to range from 680 to 1030mm.
- Fitted with adjustable feet to ensure work surface is level.

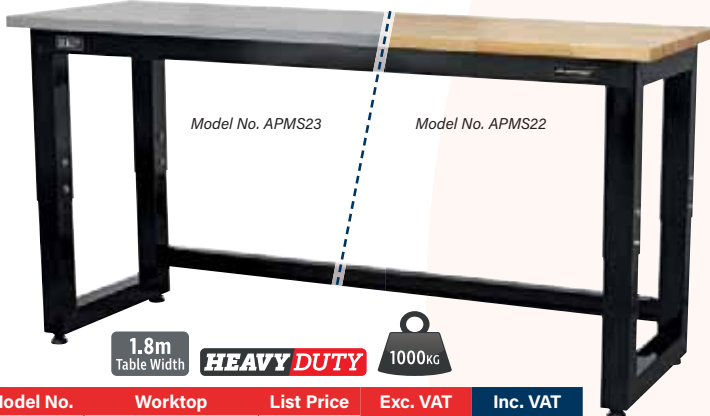

1.8m Table Width

HEAVY DUTY



Model No.	Worktop	List Price	Exc. VAT	Inc. VAT
APMS23	Stainless Steel	£699.95	£599.95	£719.94
APMS22	Solid Wood	£619.95	£509.95	£611.94

2108mm HEAVY-DUTY MODULAR FULL HEIGHT FLOOR CABINET



- Use as part of a complete professional garage storage system or as an individual storage unit.
- All steel construction with a graphite powder coat finish.
- Heavy-duty full height single door cabinet.
- Three adjustable shelves.
- Four level-adjusting feet.
- Added security provided by cylinder lock, supplied with two keys.
- Requires some self-assembly.
- Supplied flat-packed for ease of transportation.
- Overall Size (W x D x H): 610 x 610 x 2108mm.
- Model No. **APMS21**
- List Price £649.95

£539.95 Exc. VAT
£647.94 Inc. VAT

680mm MODULAR POWER TOOL RACK



- Five open fronted power tool storage bays.
- Fully welded with a hammered metal finish.
- Specifically designed to fit APMS wall cabinets.
- Suitable for use with APMS53 and APMS65.
- Minimal assembly required.
- **Model No. APMS69**
- List Price £99.95

£65.95 Exc. VAT
£79.14 Inc. VAT

645mm MODULAR SHELF



- Tough and durable easy fit shelf with hammered metal finish.
- To be used specifically with APMS50BP or APMS60BP.
- Suitable to fit on the back panel of the APMS Superline Pro® Wall Cabinets and Storage Systems.
- Some simple assembly required.
- **Model No. APMS70**
- List Price £39.95

£26.95 Exc. VAT
£32.34 Inc. VAT

HAZARDOUS SUBSTANCE CABINETS



Ref.	Model No.	Usage (Colour-Coded)	Size (W x D x H)	List Price	Exc. VAT	Inc. VAT
A	FSC12	CoSHH	900 x 460 x 1800mm	£799.95	£549.95	£659.94
B	FSC15	CoSHH	900 x 460 x 900mm	£549.95	£399.95	£479.94
C	FSC15ST	Floor Stand for FSC15	920 x 465 x 575mm	£209.95	£159.95	£191.94
D	FSC13	Acid/Alkali	900 x 460 x 1800mm	£819.95	£599.95	£719.94
E	FSC16	Acid/Alkali	900 x 460 x 900mm	£579.95	£419.95	£503.94
F	FSC16ST	Floor Stand for FSC16	920 x 465 x 575mm	£209.95	£159.95	£191.94
G	FSC14	Pesticide/Agrochemical	900 x 460 x 1800mm	£819.95	£599.95	£719.94
H	FSC17	Pesticide/Agrochemical	900 x 460 x 900mm	£579.95	£419.95	£503.94
I	FSC17ST	Floor Stand for FSC17	920 x 465 x 575mm	£220.45	£159.95	£191.94



- Sturdy metal construction with colour-coded powder coat.
- Two door, with 2-point key lock and two keys.
- Features adjustable, lipped shelves and liquid-tight base to retain spills.
- Powder coating has germ guard active technology and anti-bacterial paint.
- Reaction to Fire classification EN13501-1.
- Shelf capacity is 70kg evenly distributed.

MODULAR VAN STORAGE SYSTEMS



Optional Lockable Door



- Versatile sprung system allows you to place the door in any section of the frame to create the lockable space.
- Strong cylinder lock supplied with two keys.
- Illustrated with APMSV01, not included.

- Modular van storage system with an appearance to enhance any mobile working environment.
- Versatile and durable steel construction that is built to last.
- Easily adjusts to specific needs and ideal for medium or large vans.
- Three shelves that can be height adjusted in 25mm increments.

Ref.	Model No.	Description	List Price	Exc. VAT	Inc. VAT
J	APMSV01	925mm Modular Flat Shelf	£299.95	£229.95	£275.94
K	APMSV02	925mm Modular Slanted Shelf	£269.95	£209.95	£251.94
L	APMSV03	845mm Modular Lockable Storage Door	£49.95	£41.95	£50.34

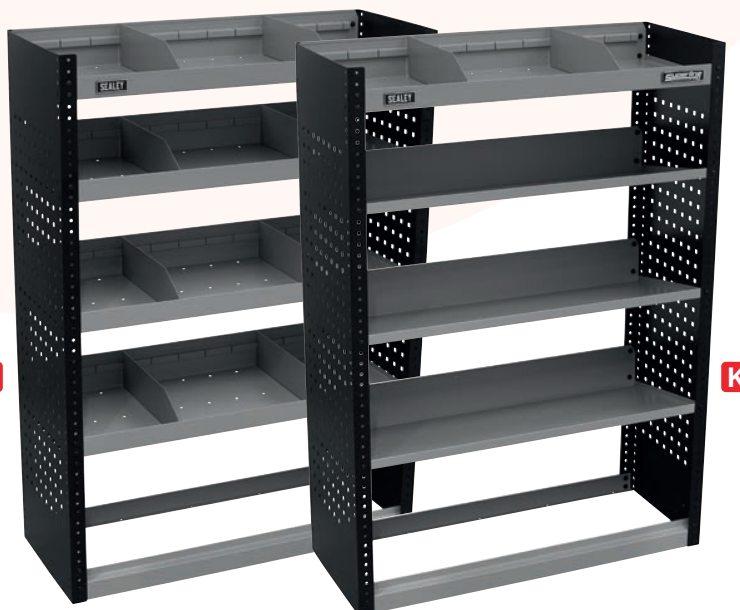

K

COLLAPSIBLE STORAGE BINS



- Made of sturdy plastic.
- Easy snap connection makes these boxes extremely versatile.
- Ideal for use in all areas of life from the workplace to the home where creating temporary and flexible work areas is key.
- Fully collapsible and stackable when not in use.



Model No.	Working size (W x D x H)	Capacity	List Price	Exc. VAT	Inc. VAT
CB85L	216 x 336 x 175mm	8.5L	£8.45	£6.45	£7.74
CB15L	270 x 420 x 200mm	15L	£13.95	£9.95	£11.94
CB30L	303 x 500 x 275mm	30L	£26.95	£19.95	£23.94
CB55L	400 x 600 x 321mm	55L	£36.95	£26.95	£32.34

DOUBLE POUCH LEATHER TOOL BELT



- Double pocket split leather tool belt.
- 11 pockets including two large pouches, two hammer loops, two nail pouches, a knife holder, measuring tape holder and four screwdriver holders.
- Adjustable 50mm wide webbing belt (maximum 48").
- With side release style buckle fastening.
- **Model No. STBL01**
- List Price £14.95

£9.95 Exc. VAT
£11.94 Inc. VAT

85mm ANGLE GRINDER HOLDER



- One of a comprehensive range of accessories for PerfoTool & PerfoWall panels.
- Ideal for holding 85mm, 115mm and 125mm angle grinders.
- Suitable for Model No's API1103A, APIBP1500, APIBP1800, APIBP2100, TTS05, TTS1, TTS2, APMS50BP and APMS60BP.
- **Model No. TTS43**
- List Price £21.95

£17.95 Exc. VAT
£21.54 Inc. VAT

2 BAY ANGLE GRINDER STORAGE RACK



- Wall mounting rack specifically designed for the storage of angle grinders.
- Stores up to two angle grinders.
- Left slot can take up to Ø150mm angle grinders whilst right can take Ø180mm angle grinders.
- **Model No. AGSR2**
- List Price £29.95



£21.95 Exc. VAT
£26.34 Inc. VAT

WALL MOUNTABLE STORAGE HOOKS SET OF 4



- Set of four wall mountable storage hooks ideal for organizing your garage or workshop.
- Heavy-duty construction.
- Capacity of 50kg per hook.
- Used to store vehicle wheels as well as items such as ladders and bicycles.
- Easy to fit with all mounting hardware included.
- **Model No. APWH**
- List Price £59.95

£44.95 Exc. VAT
£53.94 Inc. VAT



SPACE WARMER® KEROSENE/DIESEL HEATERS



KEROSENE

DIESEL



- Workshop tried and tested, our range of Kerosene/Diesel heaters represents excellent value.
- All models have a digital adjustable thermostat (°C) and are also fitted with digital room temperature (°C) display/error code read-out (except Model No. AB2050, this has no digital display but can still be thermostatically controlled).
- Proven pump systems handle either kerosene or diesel with only minor adjustment of air compressor.
- All models are fitted with a fuel tank gauge and heavy-duty fuel cap.
- Model No AB2380 is fitted with fuel tank drain plug, sturdy handle and equipped with Danfoss oil nozzle and gear pump for stable fuel delivery.



Model No. AB2380
240k Btu/hr



Model No. AB2050
205k Btu/hr



Model No. AB350
35k Btu/hr

Model No.	Heat Output	Digital Display	Wheels	List Price	Exc. VAT	Inc. VAT
AB350	35,000Btu/hr(10kW)	✓	X	£349.95	£249.95	£299.94
AB2050	205,000Btu/hr(60kW)	X	✓	£639.95	£449.95	£539.94
AB2380	240,000Btu/hr(70kW)	✓	✓	£1,049.95	£699.95	£839.94



INDUSTRIAL INFRARED DIESEL HEATERS



Model No. IR13 13kW



16kW Model No. IR16

- Versatile and compact diesel-fuelled Infrared technology heaters have no electric fan, meaning there is no air movement and the heat is spread evenly in all directions, quietly and dust-free.
- Ideal for use in well-ventilated indoor areas including garages, workshops, warehouses and marquees.
- Extremely inexpensive to run, using only around 1L of fuel per hour.
- Clean burn and precisely controlled fuel supply, ensure that no unpleasant odours or carbon monoxide enter the air.
- Equipped with advanced safety features including overheat protection, auto-misfire, tilt, shock, low fuel shut-off sensors and flame-out fuel cut.
- Features 24hr timer and temperature control thermostat.
- Soft-touch control panel with LED display.
- Fitted with four castor wheels for easy manoeuvrability.



Diesel
3 YEAR GUARANTEE



STAINLESS STEEL



C

Ø100mm STAINLESS STEEL EXHAUST/FLUE PIPES

- 201 stainless steel exhaust/flue pipes.
- Designed for use with Sealey IR13/IR16.

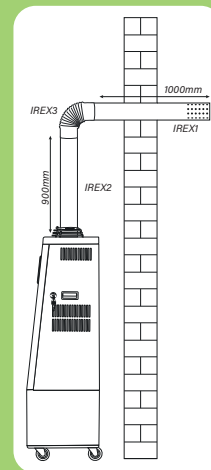

Model No.	Heat Output	Heated Area	List Price	Exc. VAT	Inc. VAT
IR13	44,500btu/hr(13kW)	11'477ft ³ (325m ³)	£1,499.95	£1,199.95	£1,439.94
IR16	55,000btu/hr(16kW)	14'125ft ³ (400m ³)	£1,699.95	£1,399.95	£1,679.94

Ref.	Model No.	Description	List Price	Exc. VAT	Inc. VAT
A	IREX1	900mm End Section	£26.95	£21.95	£26.34
B	IREX2	1000mm Extension	£23.95	£19.95	£23.94
C	IREX3	90° Bend	£11.95	£9.95	£11.94

INDUSTRIAL FAN HEATERS

2400W OR 3000W



- Portable Industrial heaters with a fan only and two heat settings.
- Tough composite case with integral carry handle.
- Full range ambient room thermostat maintains temperature.
- Fan doubles as cool air blower for use in the summer.
- Size (W x D x H): 300 x 267 x 332mm.



Model No.	Power	List Price	Exc. VAT	Inc. VAT
FH2400	2400W	£73.95	£49.95	£59.94
FH3000	3000W	£99.95	£69.95	£83.94

INDUSTRIAL CERAMIC FAN HEATERS

2000W OR 2800W



- Portable industrial heaters with a fan only and two heat settings.
- Features PTC heat conducting ceramic elements to achieve an instant, odour-free heat.
- Thermostat control to maintain ambient temperature.
- Includes overheating protection, protecting the user, product and environment.



Model No.	Power	List Price	Exc. VAT	Inc. VAT
CH20	2000W	£44.95	£34.95	£41.94
CH28	2800W	£79.95	£59.95	£71.94

INFRARED CABINET HEATERS



2400W
OR
2800W

Model No. IR14110V

110V



Model No. IR14 230V



- Powder coated metal cabinets with two ruby halogen infrared elements and chemically polished reflectors for maximum heat emission.
- Adjustable thermostat control (15°C – 45°C)
- Soft-touch control panel with LED display.
- Programmable 7-day timer function.
- Equipped with a tilt cutout switch for added safety.
- Features easy-rolling castors (two locking).

Model No.	Min./Max. Power	Supply	List Price	Exc. VAT	Inc. VAT
IR14	1.4/2.8kW	230V - 13A	£329.95	£229.95	£275.94
IR14110V	1.2/2.4kW	110V - 32A	£339.95	£239.95	£287.94

INFRARED HALOGEN HEATERS



Model No. IR15110V

110V



Model No. IR15 230V

2400W OR 2800W



- Powder coated metal construction with tilting head giving directional heat control.
- Adjustable thermostat control (15°C – 45°C)
- Soft-touch control panel with LED display.
- Programmable 7-day timer function.
- Equipped with a tilt cutout switch for added safety.
- Fitted with two ruby halogen infrared elements and chemically polished reflectors for maximum heat emission.
- Stand features easy-rolling castors with a locking castor.
- Heater Dimensions (W x D x H): 597 x 488 x 792mm.

Model No.	Min./Max. Power	Supply	List Price	Exc. VAT	Inc. VAT
IR15	1.4/2.8kW	230V - 13A	£349.95	£249.95	£299.94
IR15110V	1.2/2.4kW	110V - 32A	£359.95	£259.95	£311.94

CERAMIC HEATERS



Model No. CH30110V



2400W
OR
2800W

110V



230V

Model No. CH30

- Powder coated metal construction with two ceramic heating elements providing instant heat when required.
- Adjustable thermostat control (15°C – 45°C).
- Soft-touch control panel with LED display.
- Programmable 7-day timer function.
- Equipped with a tilt cutout switch for added safety.
- Polished reflectors maximize heat emission.
- Fitted with sturdy frame and carry handle.
- Dimensions (W x D x H): 395 x 387 x 668mm.

Model No.	Min./Max. Power	Supply	List Price	Exc. VAT	Inc. VAT
CH30	1.4/2.8kW	230V - 13A	£239.95	£169.95	£203.94
CH30110V	1.2/2.4kW	110V - 32A	£249.95	£174.95	£209.94

CERAMIC HEATERS WITH TELESCOPIC TRIPOD STAND

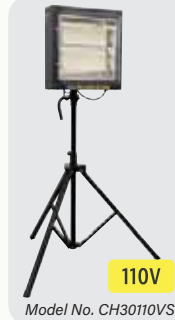

Model No. CH30110VS

110V



2400W
OR
2800W



230V

Model No. CH30S

- Tripod mounted, powder coated metal construction.
- Adjustable thermostat control (15°C – 45°C)
- Soft-touch control panel with LED display.
- Programmable 7-day timer function.
- Equipped with a tilt cutout switch for added safety.
- Two ceramic heating elements provide instant heat when required.
- Polished reflectors maximize heat emission.
- Supplied with 2m cable.
- Heater Dimensions (W x D x H): 395 x 190 x 413mm.

Model No.	Min./Max. Power	Supply	List Price	Exc. VAT	Inc. VAT
CH30S	1.4/2.8kW	230V - 13A	£329.95	£229.95	£275.94
CH30110VS	1.2/2.4kW	110V - 32A	£339.95	£239.95	£287.94

7,000BTU/HR PORTABLE AIR CONDITIONER/DEHUMIDIFIER/AIR COOLER



Soft-touch control panel with LED digital display and remote control.

- 3-in-1 High capacity, compact, portable air conditioner, air cooling with ventilation and dehumidifying functions.
 - Thermostatically controlled with built-in 24hr timer and sleep mode.
 - Self-evaporating system allows better efficiency, low maintenance and powerful cooling.
 - Water-full indicator with auto-shut-off.
 - Supplied with extendable exhaust ducting with window kit for ventilation and continuous drain hose.
 - Eco-Friendly R290 refrigerant.
 - Air conditioning temperature range 16-32°C.
 - Washable filter.
 - Auto-defrost function at low ambient temperature.
- **Model No. SAC7000**
• List Price £399.95

£279.95 Exc. VAT
£335.94 Inc. VAT



Includes Remote

12" OSCILLATING DESK TOWER FAN 2-SPEED

12"
2-Speed
230V



- Matte finish with 2-speed and oscillating functions.
 - Smooth running highly durable copper motor powers fan blades and oscillating motor to aid powerful and even air distribution.
 - Fitted with 3-pin plug.
- **Model No. STF12C**
• List Price £29.95

£24.95 Exc. VAT
£29.94 Inc. VAT

50L INDUSTRIAL DEHUMIDIFIER 110V



50L
110V
Dehumidifier

- Powerful dehumidification capacity, extracts up to 50L of water per day.
 - Removes excess moisture from air, preventing build-up of mildew and mould.
 - Features auto-defrost function, which activates if the room temperature falls too low.
 - 24hr Timer function for delay starting and auto-shut-off.
 - Washable air filter.
 - Refrigerant is environmentally friendly R290.
 - May be connected to a drain hose for continuous operation.
 - Mounted on castors for manoeuvrability.
 - Fitted with 110V plug.
- **Model No. SDH50110V**
• List Price £769.95

£629.95 Exc. VAT
£755.94 Inc. VAT

90L INDUSTRIAL DEHUMIDIFIER



90L
230V
Dehumidifier



- Powerful dehumidification capacity, extracts up to 90 litres of water per day.
 - Removes excess moisture from air, preventing build-up of mildew and mould.
 - Features auto-defrost function, which activates if the room temperature falls too low.
 - 24hr Timer function for delay starting and auto-shut-off.
 - Washable air filter.
 - Refrigerant is environmentally friendly R290.
 - Features a permanent drain hose for continuous operation.
 - Mounted on castors for manoeuvrability.
- **Model No. SDH90**
• List Price £1,299.95

£999.95 Exc. VAT
£1,199.94 Inc. VAT

16" QUIET HIGH PERFORMANCE OSCILLATING PEDESTAL FAN



16" 230V
QUIET RUNNING
Oscillation Function
5-SPEED
ErP Compliant

- High performance stand fan with advanced aerodynamic blades for maximum air movement.
 - Quiet operation and high durability motor.
 - Five carefully programmed modes include - Sleep/Calm/Refresh/Cool/Power.
 - Offers quiet oscillation and adjustable fan head allowing great airflow in any room.
 - Additional features include an 8hr timer, auto-dimming LED control panel and fully functional remote control and remote storage.
 - Metal grill and height adjustment up to 1.4m(55").
 - Weighted base for extra stability and easy-to-assemble, tool-free.
- **Model No. SFF16Q**
• List Price £84.95

£69.95 Exc. VAT
£83.94 Inc. VAT



43" QUIET HIGH PERFORMANCE OSCILLATING TOWER FAN



43" 230V
Includes Remote
QUIET RUNNING
Oscillation Function
5-Speed
ErP Compliant

- High performance tower fan with advanced centrifugal blades for maximum air movement.
 - Quiet operation and high durability motor.
 - Five carefully programmed modes include - Sleep/Calm/Refresh/Cool/Power.
 - Offers quiet 70° oscillation allowing great airflow in any room.
 - Additional features include an 8hr timer, Easy-touch, Auto-dimming LED control panel and fully functional remote control and remote storage.
 - Built-in handle.
 - Ideal for home, bedroom and office environments.
 - Easy-to-assemble, tool-free.
- **Model No. STF43Q**
• List Price £109.95

£89.95 Exc. VAT
£107.94 Inc. VAT



LEVELLING RAMPS WITH RAMP CHOCKS

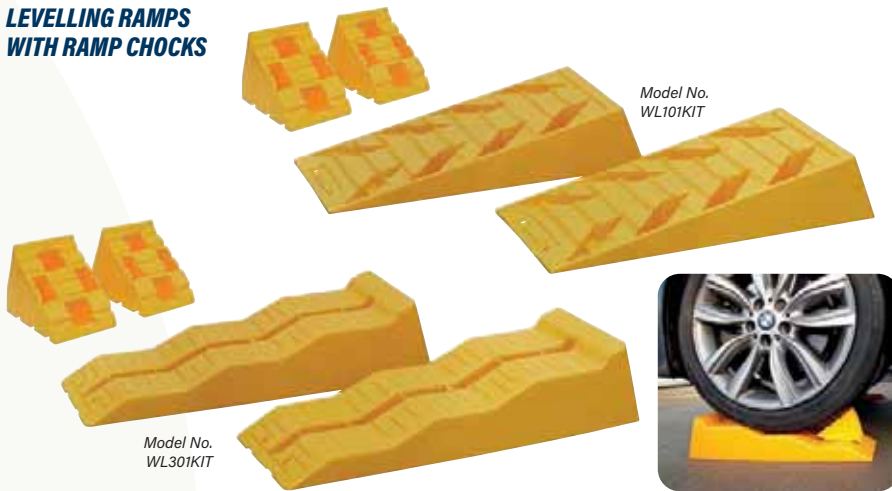

Model No.	Contents	List Price	Exc. VAT	Inc. VAT
WL101KIT	WL101 - Levelling Ramps - 4 Tonne Capacity per Pair WLC01 - Levelling Ramp Chocks - Pair	£34.95	£16.95	£20.34
WL301KIT	WL301 - 3 Stage Levelling Ramps - 5 Tonne Capacity per pair WLC01 - Levelling Ramp Chocks - Pair	£41.45	£19.95	£23.94

20L 3-IN-1 ASH VACUUM CLEANER 1200W/230V

- A powerful 1200W motor provides great suction performance whilst also acting as a blower.
- With a 20L capacity, the lightweight tank features quick release clips for ease of emptying.
- A 1.2m flexible metal lined suction hose allows the suction of ash up to a temperature of 40°C(100°F).
- Easily switch to blow function by using the outlet on the top of the vacuum.
- Features filter cleaning function by placing the end of the nozzle on the button at the top of the unit.
- Includes a HEPA filter with metal cover preventing the leaking of ash and dust and round aluminium nozzle.
- Cable length 2.5m.
- **Model No. PC200A**
- List Price £84.95

20L
1200W



£64.95 Exc. VAT
£77.94 Inc. VAT

HEPA CARTRIDGE FILTER FOR PC200A

- **Model No. PC200ACF**
- List Price £13.95



£10.95 Exc. VAT
£13.14 Inc. VAT

PLAIN WHITE TOILET ROLLS PACK OF 4 X 10 (40 ROLLS)



- Embossed 2-ply soft white toilet rolls.
- Sheets: 320/Roll.
- Wrapped in sleeves of 4 rolls.
- Pack Quantity: 40 rolls.
- **Model No. TOL40**
- List Price £34.95

£26.95 Exc. VAT
£32.34 Inc. VAT

GENERAL-PURPOSE POLYPROPYLENE SHOVEL WITH 690MM HANDLE

- Heavy duty one-piece polypropylene shovel with extra-wide blade and D-shaped handle for comfort during use.
- Blade width: 330mm and 460mm long.
- **Model No. SS10**
- List Price £39.95



£31.95 Exc. VAT
£38.34 Inc. VAT

GUTTER SCOOP



- Lightweight and durable polypropylene scoop.
- Can be used for various tasks including sowing plant and grass seeds, as well as clearing gutters.
- **Model No. GS01**
- List Price £4.65

£3.45 Exc. VAT
£4.14 Inc. VAT

SNOW FOAM SPRAYER FOR PW1601/PW1850



- For use with Pressure Washer Model No's PW1601 and PW1850 to apply snow foam.
- Our tests show that a good covering of snow type foam is only possible with a pressure washer and a compatible foam gun.
- Includes variable nozzle and detergent regulator.
- **Model No. PW0SNA**
- List Price £13.95

£8.95 Exc. VAT
£10.74 Inc. VAT

5L SNOW FOAM CAR SHAMPOO



5L

- The ultimate high snow foaming traffic film removal solution.
- This thick rich cleaning snow foam will allow longer dwell time to break down dirt and soiling.
- Non-wax stripping, PH neutral, easy rinse for a streak-free finish.
- Perfect for car detailing.
- **Model No. SCS090**
- List Price £26.45

£19.95 Exc. VAT
£23.94 Inc. VAT

HEAVY-DUTY FLEXI TUBS

Model No. SFT40



- Manufactured from heavy-duty polyethylene with a versatile, flexible construction.
- Ideal for a wide range of domestic and industrial applications.

Model No.	Capacity	List Price	Exc. VAT	Inc. VAT
SFT30	30L	£7.45	£4.95	£5.94
SFT40	40L	£8.95	£5.95	£7.14
SFT65	65L	£14.95	£10.95	£13.14

COAL SHOVELS



Model No. SS09

Model No. SS07

- Ideal for removing hot ashes or coals from fireplaces or wood stoves.

Model No.	Head	Handle	List Price	Exc. VAT	Inc. VAT
SS07	4"	160mm Steel	£3.95	£3.25	£3.90
SS08	6"	185mm Steel	£5.45	£4.45	£5.34
SS09	8"	228mm Wood	£7.45	£6.25	£7.50

REFUSE/STORAGE BINS

- Durable refuse/storage bins made from polypropylene.
- Fitted with lid latches to keep lid secure and carry handles.
- Suitable for outdoor use.



50L



75L



95L



Model No.	Capacity	Colour	List Price	Exc. VAT	Inc. VAT
BM50	50L	Black	£24.95	£17.95	£21.54
BM75	75L		£34.95	£24.95	£29.94
BM95	95L		£44.95	£31.95	£38.34
BM50B	50L	Blue	£24.95	£17.95	£21.54
BM75B	75L		£34.95	£24.95	£29.94
BM95B	95L		£44.95	£31.95	£38.34
BM50R	50L	Red	£24.95	£17.95	£21.54
BM75R	75L		£34.95	£24.95	£29.94
BM95R	95L		£44.95	£31.95	£38.34
BM50G	50L	Green	£24.95	£17.95	£21.54
BM75G	75L		£34.95	£24.95	£29.94
BM95G	95L		£44.95	£31.95	£38.34



Model No. CM450

WALL MOUNTING CONVEX MIRRORS

- Convex mirrors for improved visibility.
- Supplied with wall fixing and adjustable swivel joint, allowing for quick and easy positioning.

Model No.	Diameter	List Price	Exc. VAT	Inc. VAT
CM300	Ø300mm	£36.95	£28.95	£34.74
CM450	Ø450mm	£52.95	£41.95	£50.34

25MM X 5M RATCHET TIE DOWNS WITH CORNER PROTECTOR 600KG BREAKING STRENGTH

25mm 5m 600kg

- Manufactured from polyester webbing.
- Ratchet mechanically tensions the webbing using a simple drum and ratchet mechanism providing superior load restraint.
- Packaged on a corner protector to allow for immediate use without having to worry about damaged goods.

Model No.	Type	List Price	Exc. VAT	Inc. VAT
TD0635E	Self-Securing Ratchet Tie Down	£9.95	£7.95	£9.54
TD0635S	S-Hook Ratchet Tie Down	£13.95	£10.95	£13.14

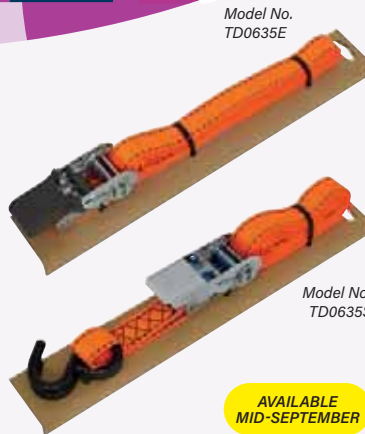

Model No. TD0635E

Model No. TD0635S

AVAILABLE MID-SEPTEMBER

2PC WIRELESS SMD LED TRAILER LIGHT SET

2 YEAR GUARANTEE

SMD LED

7-PIN N-Type Plug



Wireless

- Magnetic rechargeable battery wireless rear trailer lights.
- Battery powered lights controlled by transmitter plugged into 7-pin light socket on tow bar.
- Lights have four functions, stop/brake, position/tail, number plate light and sequential indicator (road legal E9 mark).
- No tools required simply attach lights to trailer and plug in transmitter, no wires required, transmitter range 20m.
- Supplied in storage case.
- Model No. TB18LEDW
- List Price £89.95

£69.95 Exc. VAT
£83.94 Inc. VAT

8L DUST SUPPRESSION WATER TANK

8L

WORKSAFE BY SEALEY



- Effective at suppressing dust while using cut-off saws, bench saws and floor saws in all working environments.
- Automatic pressure release valve stops pressure building higher than 3bar for optimum use.
- Includes 3m hose with quick release coupling.
- Model No. DST08
- List Price £34.95

£19.95 Exc. VAT
£23.94 Inc. VAT



2-STROKE PETROL EARTH AUGER



- Drills holes up to 800mm deep and 200mm wide, ideal for seating trees, garden posts and fence supports into the ground.
- 52cc 2hp Petrol motor.
- Three different diameter bore sizes - Ø100, 150 or 200mm.
- Twin ergonomic handles for comfort and ease of use (by one or two people).
- Auger brake automatically stops the bit from turning if hard underground impediment is hit.
- 1.2L Fuel tank capacity.
- Model No. PHA100
- List Price £239.95

£219.95 Exc. VAT
£263.94 Inc. VAT

200MM SMOOTH CUT ENGINEER'S FILES

- Smooth cut files for a finer finish to the workpiece.
- Each file is double cut for faster removal of material from workpiece.
- Features comfort grip handles with hanging holes.



Model No. AK586

5pc Set of all single models.

Model No.	File Type	List Price	Exc. VAT	Inc. VAT
AK5861	Half-Round	£8.95	£5.95	£7.14
AK5862	Round	£7.95	£5.45	£6.54
AK5863	Square	£8.25	£5.45	£6.54
AK5864	3-Square	£8.75	£5.75	£6.90
AK5865	Flat	£8.35	£5.45	£6.54
AK586	5pc Set of all single models	£37.95	£24.95	£29.94



Premier

LIFETIME GUARANTEE

8PC FILE & RASP SET

Premier

LIFETIME GUARANTEE

- Selection of popular second cut medium-coarse files and wood rasps.
- Soft grip handles for comfort and control.
- Contents: 200mm Second Cut Engineer's Files; 3-Square, Half-Round, Round, Flat, Square, Hand File, 200mm Wood Rasps; Half-Round, Round.
- Supplied in a pouch.
- **Model No. AK582**
- List Price £46.95



£33.95 Exc. VAT
£40.74 Inc. VAT

16PC ENGINEER'S & NEEDLE FILE SET

Siegen

- Soft grip handles for comfort and control.
- Each file is second cut for faster removal of material from workpiece.
- Contents: 200mm engineer's files; Round, Half-Round, 3-Square, Flat Taper, 140mm Needle files; Flat Parallel, Half-Round, 3-Square, Square, Round, Flat Taper, Knife Form, Barrete, Crossing, Oval Form, Joint Round Edge, Feather Edge.
- **Model No. S05781**
- List Price £29.95



£21.95 Exc. VAT
£26.34 Inc. VAT

MINI MITRE BOXES



Model No. MB01 - Performs 45° and 90° mitre cuts.



Model No. MB02 - Performs 22.5°, 45° and 90° mitre cuts and 45° Bevel Cut.

- Made from high strength plastic.
- Boxes can be fixed to the workbench via two fixing holes.

Model No.	Size	List Price	Exc. VAT	Inc. VAT
MB01	250 x 85 x 50mm	£4.95	£3.95	£4.74
MB02	310 x 170 x 110mm	£13.95	£10.95	£13.14

235mm & 163mm WOOD PLANER SET



- 2-Piece wood planer set.
- 235mm Smooth Plane: Blade Length 80mm, Blade Width 45mm, Blade Thickness 1.5mm.
- 163mm Block Plane: Blade Length 90mm, Blade Width 40mm, Blade Thickness 2mm.
- Hardened, adjustable 65Mn steel blade.
- Plastic handle and knob for added comfort.
- Suitable for professional or DIY carpentry.
- **Model No. S06092**
- List Price £17.95

£12.45 Exc. VAT
£14.94 Inc. VAT

5PC 200mm INTERCHANGEABLE FILE SET

Siegen

200mm



- Popular set of assorted second cut coarse files with interchangeable comfort grip handle.
- Each file is double cut for faster removal of material from workpiece.
- Contents: Half-Round, Round, Square, 3-Square, Flat.
- **Model No. S0573**
- List Price £24.95

£16.95 Exc. VAT
£20.34 Inc. VAT

24PC TAP & SPLIT DIE SET IMPERIAL

- Precision machined, carbon steel taps and dies.
- Dies are split to facilitate the fine adjustment of core diameter.
- Set includes imperial coarse and fine sizes.



Split Dies IMP

Contents:

Taps & Dies in following sizes; 1/4"-20, 1/4"-28, 5/16"-18, 5/16"-24, 3/8"-16, 3/8"-24, 7/16"-14, 7/16"-20, 1/2"-13, 1/2"-20, 1/8"-27 and double-ended tap wrench and die holder with retention screw.

- **Model No. AK3024IMP**
- List Price £39.95

£27.95 Exc. VAT
£33.54 Inc. VAT

110PC TAP & DIE SET

MM

- Precision machined, high quality alloy steel taps and dies.
- 35 Dies are split to facilitate the fine adjustment of core diameter.
- Set includes Taper and Plug taps for each size.



Contents:

Fine Tap and Dies:
6 x 0.75, 7 x 0.75, 8 x 0.75, 9 x 0.75, 10 x 0.75, 10 x 1, 11 x 0.75, 11 x 1, 12 x 0.75, 12 x 1, 14 x 1, 14 x 1.25, 16 x 1mm.
Coarse Tap and Dies:
2 x 0.4, 3 x 0.5, 4 x 0.7, 5 x 0.8, 6 x 1, 7 x 1, 8 x 1, 8 x 1.25, 9 x 1.0, 9 x 1.25, 10 x 1.25, 10 x 1.5, 11 x 1.25, 11 x 1.5, 12 x 1.25, 12 x 1.5, 12 x 1.75, 14 x 1.5, 14 x 2.0, 16 x 1.5, 16 x 2.0, 18 x 1.5, Double-Ended Tap Wrench (x2), Tap Wrench with Screw Retention (x2), T-type Tap Wrench.

- **Model No. AK30110**
- List Price £219.95

£159.95 Exc. VAT
£191.94 Inc. VAT

49PC MASTER EXTRACTOR SET

- Left-handed HSS drill bits, used to drill pilot holes (reversible drill is required).
- Spiral flute extractors for use with bolts/fasteners requiring less torque.
- Multi-spline extractors when higher torque or restricted access is required.

Contents:

5/64", 7/64", 1/8", 5/32", 3/16", 7/32", 1/4", 9/32", 19/64", 5/16", 11/32", 3/8", 13/32", 7/16", 15/32", 1/2", Spiral Flutes; #1, #2, #3, #4, #5, #6, Multi-Spline Extractors; 1/8", 5/32", 3/16", 7/32", 1/4", 9/32", 5/16", 11/32", 3/8", 13/32", 7/16", 15/32", 1/2", Reverse Spiral Bolt Extractors; 1/4", 5/16" (8mm), 3/8", 10mm, 7/16" (11mm), 12mm, 1/2", 13mm, 9/16" (14mm), 5/8" (16mm), 17mm, 11/16", 3/4" (19mm).

- **Model No. AK8149**
- List Price £159.95

£119.95 Exc. VAT
£143.94 Inc. VAT

60PC TAP & DIE SET - METRIC & IMPERIAL

MM & IMP Split Dies

- Split dies with machined lead-ins for ease of use.
- Die holder features self-centring mechanism for straight and accurate thread cutting.



Contents:

Taps and Dies; 3 x 0.5, 4 x 0.7, 5 x 0.8, 6 x 1.0, 7 x 1.0, 8 x 1.25, 9 x 1.25, 10 x 1.5, 10 x 1, 12 x 1.75mm, 4-40, 6-32, 8-32, 10-24, 10-32, 12-24, 1/4"-20, 1/4"-28, 5/16"-18, 5/16"-24, 3/8"-16, 3/8"-24, 7/16"-14, 7/16"-20, 1/2"-13, 1/2"-20, 1/8"-27, Die Handle, Double End Tap Wrench, T-handed Tap Wrench, Metric Screw Pitch Gauge, Imperial Screw Pitch Gauge and slotted 5mm Screwdriver.

- **Model No. AK3060**
- List Price £99.95

£69.95 Exc. VAT
£83.94 Inc. VAT

86PC HEXAGONAL TAP & DIE SET METRIC & IMPERIAL

MM & IMP HEX

- Features hex shaped dies providing a more secure fit in the die holder.
- Dies can also be used with a socket or spanner.



Contents:

3 x 0.5, 4 x 0.7, 5 x 0.8, 6 x 1, 7 x 1, 8 x 1, 8 x 1.25, 9 x 1.25, 10 x 1.5, 10 x 1.25, 11 x 1.5, 11 x 1.25, 12 x 1.5, 12 x 1.75, 14 x 2, 14 x 1.5, 16 x 2, 16 x 1.5mm and 4-40, 6-32, 8-32, 10-24, 10-32, 12-24, 1/2"-13, 1/2"-20, 1/4"-20, 1/4"-28, 1/8"-27, 3/8"-16, 3/8"-24, 5/8"-11, 5/8"-18, 5/16"-18, 5/16"-24, 7/16"-14, 7/16"-20, 9/16"-12, 9/16"-18 and T-handed tap wrench, double-ended tap wrench, die handle, Metric and Imperial thread gauge and screwdriver.

- **Model No. AK3086HIM**
- List Price £199.95

£149.95 Exc. VAT
£179.94 Inc. VAT

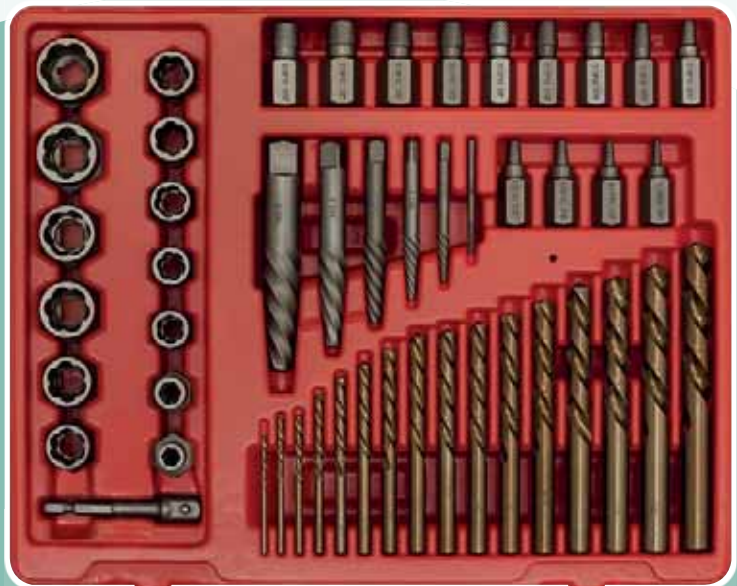

3/8" Sq. Drive MM & IMP

50-IN-1 POCKET MULTI TOOL

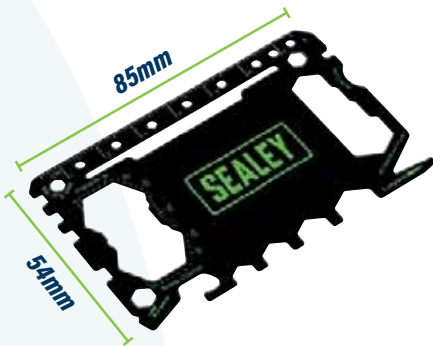

- Highly versatile 50-in-1 multi-tool.
- Credit card size.
- Easily stores in your pocket, wallet or purse.
- Functions include a screwdriver, ruler, wire cutter, protractor, bottle opener and many more.
- Size (W x D x H) 85 x 1.2 x 54mm.
- Made from steel.
- **Model No. MT501**
- List Price £4.95

£3.45 Exc. VAT
£4.14 Inc. VAT

DUAL READING DIGITAL DIAL BORE GAUGE



- Digital dial bore gauge for use in precision engineering.
- Digital display shows both Metric and Imperial measurements.
- Measuring range between 0-25.4mm.
- Features lugged back plate for mounting on magnetic bases.
- **Model No. DBG506D**
- List Price £49.95

£36.95 Exc. VAT
£44.34 Inc. VAT

ALUMINIUM MITRE SAW PROTRACTOR



- Durable aluminium tool measures angles for mitre and single cuts.
- Precision laser engraved scales for accurate reading.
- Circular body allows for simple and smooth operation.
- Suitable for wide range of uses such as crown molding, casing, flooring, carpentry, plumbing and more.
- **Model No. SMS7P**
- List Price £24.95

£19.95 Exc. VAT
£23.94 Inc. VAT

1-30mm TAPER BORE GAUGE



- Precision engineered tool for measuring gaps and hole diameters.
- Laser cut from stainless steel.
- Measuring range of 1-30mm.
- Features a precision scale for accurate inspections.
- Allows for use of Imperial increments on the reverse side of taper gauge.
- **Model No. AK74TPG**
- List Price £10.95

£7.95 Exc. VAT
£9.54 Inc. VAT

4PC TAPER BORE GAUGE 1-30mm



- Pocket-size Metric taper gauge.
- Precision engineered tool for measuring gaps and hole diameters.
- Laser cut from stainless steel.
- Measuring range: 1-8mm, 8-15mm, 15-22mm and 22-30mm.
- Features a precision scale for accurate inspections.
- **Model No. AK75TPG**
- List Price £16.95

£11.95 Exc. VAT
£14.34 Inc. VAT

DOVETAIL MARKER



- Precision engineered tool for marking out dovetails quickly.
- CNC Machined from anodised aluminium.
- Outside edges offer slopes of 1:5 and 1:8 while the inner edges have slopes of 1:6 and 1:7.
- Suitable for working with either soft or hard wood.
- Features precision scale for accurate working.
- **Model No. AK609DT**
- List Price £9.95

£7.95 Exc. VAT
£9.54 Inc. VAT

NUT & BOLT THREAD CHECKER IMPERIAL/METRIC

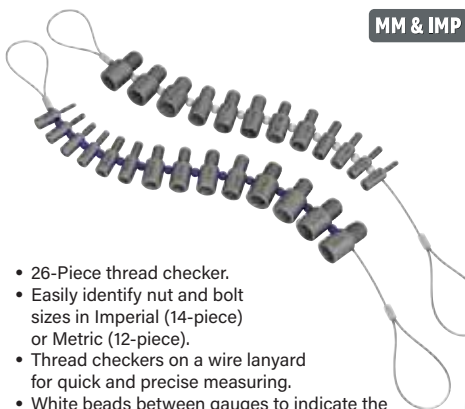

- 26-Piece thread checker.
- Easily identify nut and bolt sizes in Imperial (14-piece) or Metric (12-piece).
- Thread checkers on a wire lanyard for quick and precise measuring.
- White beads between gauges to indicate the metric sizes and blue to indicate imperial.
- Convenient loops on each end for hanging.
- Imperial Sizes UNC/UNF: 6-32, 8-32, 10-24, 10-32, 1/4"-20, 1/4"-28, 5/16"-18, 5/16"-24, 3/8"-16, 3/8"-24, 7/16"-14, 7/16"-20, 1/2"-13, 1/2"-20.
- Metric Sizes: M4-0.7, M5-0.8, M6-1.0, M7-1.0, M8-1.0, M8-1.25, M10-1.0, M10-1.25, M10-1.5, M12-1.25, M12-1.5, M12-1.75.
- **Model No. AK70NBC**
- List Price £31.45

£21.95 Exc. VAT
£26.34 Inc. VAT

G-CLAMPS - QUICK RELEASE



- Quick release mechanism for speedy positioning.
- Forged body with smooth acting threaded clamp.
- Fitted with swivel tip to reduce marking.

Model No.	Throat Depth	List Price	Exc. VAT	Inc. VAT
AK6004Q	100mm	£14.95	£10.95	£13.14
AK6006Q	150mm	£23.95	£16.95	£20.34

4PC G-CLAMP SETS

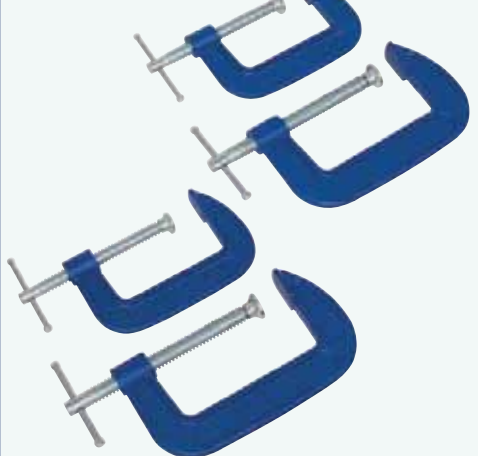

Model No.	Sizes	List Price	Exc. VAT	Inc. VAT
AK6003SET	75mm (x2) 100mm (x2)	£33.95	£22.95	£27.54
AK6006SET	150mm (x2) 200mm (x2)	£79.95	£52.95	£63.54

WEAR EYE PROTECTION WHEN WELDING - MANDATORY SAFETY SIGNS 300 x 100mm



Model No.	Pack Qty	Material	List Price	Exc. VAT	Inc. VAT
SS54P1	1	Rigid Plastic	£3.65	£3.25	£3.90
SS54P10	10	Rigid Plastic	£33.95	£29.95	£35.94
SS54V1	1	Self-Adhesive Vinyl	£2.45	£2.25	£2.70
SS54V10	10	Self-Adhesive Vinyl	£21.95	£18.95	£22.74

RESPIRATORS MUST BE WORN - MANDATORY SAFETY SIGNS 300 x 100mm



Model No.	Pack Qty	Material	List Price	Exc. VAT	Inc. VAT
SS56P1	1	Rigid Plastic	£3.65	£3.25	£3.90
SS56P10	10	Rigid Plastic	£33.95	£30.95	£37.14
SS56V1	1	Self-Adhesive Vinyl	£2.45	£2.25	£2.70
SS56V10	10	Self-Adhesive Vinyl	£21.95	£18.95	£22.74

POWDER FIRE EXTINGUISHER - SAFE CONDITIONS SAFETY SIGNS 75 x 210mm



Model No.	Pack Qty	Material	List Price	Exc. VAT	Inc. VAT
SS52P1	1	Rigid Plastic	£3.65	£3.25	£3.90
SS52P10	10	Rigid Plastic	£33.95	£28.95	£34.74
SS52V1	1	Self-Adhesive Vinyl	£1.95	£1.75	£2.10
SS52V10	10	Self-Adhesive Vinyl	£18.45	£14.95	£17.94

WEAR FACE SHIELD - MANDATORY SAFETY SIGNS 300 x 100mm



Model No.	Pack Qty	Material	List Price	Exc. VAT	Inc. VAT
SS55P1	1	Rigid Plastic	£3.65	£3.25	£3.90
SS55P10	10	Rigid Plastic	£33.95	£30.95	£37.14
SS55V1	1	Self-Adhesive Vinyl	£2.45	£2.25	£2.70
SS55V10	10	Self-Adhesive Vinyl	£21.95	£18.95	£22.74

MASKS MUST BE WORN - MANDATORY SAFETY SIGNS 300 x 100mm



Model No.	Pack Qty	Material	List Price	Exc. VAT	Inc. VAT
SS57P1	1	Rigid Plastic	£3.65	£3.25	£3.90
SS57P10	10	Rigid Plastic	£33.95	£30.95	£37.14
SS57V1	1	Self-Adhesive Vinyl	£2.45	£2.25	£2.70
SS57V10	10	Self-Adhesive Vinyl	£21.95	£18.95	£22.74

FIRE BLANKET - SAFE CONDITIONS SAFETY SIGNS 75 x 210mm



Model No.	Pack Qty	Material	List Price	Exc. VAT	Inc. VAT
SS53P1	1	Rigid Plastic	£3.65	£3.25	£3.90
SS53P10	10	Rigid Plastic	£33.95	£28.95	£34.74
SS53V1	1	Self-Adhesive Vinyl	£1.95	£1.75	£2.10
SS53V10	10	Self-Adhesive Vinyl	£18.45	£14.95	£17.94

EYE WASH - SAFE CONDITIONS SAFETY SIGNS
300 x 100mm



Model No.	Pack Qty	Material	List Price	Exc. VAT	Inc. VAT
SS58P1	1	Rigid Plastic	£3.65	£3.25	£3.90
SS58P10	10	Rigid Plastic	£33.95	£30.95	£37.14
SS58V1	1	Self-Adhesive Vinyl	£2.45	£2.25	£2.70
SS58V10	10	Self-Adhesive Vinyl	£21.95	£18.95	£22.74

DANGER WASTE OIL - WARNING SAFETY SIGNS
200 x 300mm



Model No.	Pack Qty	Material	List Price	Exc. VAT	Inc. VAT
SS60P1	1	Rigid Plastic	£3.75	£3.25	£3.90
SS60P10	10	Rigid Plastic	£35.95	£30.95	£37.14
SS60V1	1	Self-Adhesive Vinyl	£2.45	£2.25	£2.70
SS60V10	10	Self-Adhesive Vinyl	£23.45	£19.95	£23.94

DANGER PROPANE CYLINDERS - WARNING SAFETY SIGNS
200 x 300mm



Model No.	Pack Qty	Material	List Price	Exc. VAT	Inc. VAT
SS62P1	1	Rigid Plastic	£3.75	£3.25	£3.90
SS62P10	10	Rigid Plastic	£35.95	£30.95	£37.14
SS62V1	1	Self-Adhesive Vinyl	£2.45	£2.25	£2.70
SS62V10	10	Self-Adhesive Vinyl	£23.45	£19.95	£23.94

FLAMMABLE GAS - WARNING SAFETY SIGNS
200 x 300mm



Model No.	Pack Qty	Material	List Price	Exc. VAT	Inc. VAT
SS59P1	1	Rigid Plastic	£3.65	£3.25	£3.90
SS59P10	10	Rigid Plastic	£33.95	£30.95	£37.14
SS59V1	1	Self-Adhesive Vinyl	£2.45	£2.25	£2.70
SS59V10	10	Self-Adhesive Vinyl	£21.95	£19.95	£23.94

DANGER OXYGEN CYLINDERS - WARNING SAFETY SIGNS
200 x 300mm



Model No.	Pack Qty	Material	List Price	Exc. VAT	Inc. VAT
SS61P1	1	Rigid Plastic	£3.75	£3.25	£3.90
SS61P10	10	Rigid Plastic	£35.95	£30.95	£37.14
SS61V1	1	Self-Adhesive Vinyl	£2.45	£2.25	£2.70
SS61V10	10	Self-Adhesive Vinyl	£23.45	£19.95	£23.94

DANGER ACETYLENE CYLINDERS - WARNING SAFETY SIGNS
200 x 300mm



Model No.	Pack Qty	Material	List Price	Exc. VAT	Inc. VAT
SS63P1	1	Rigid Plastic	£3.75	£3.25	£3.90
SS63P10	10	Rigid Plastic	£35.95	£30.95	£37.14
SS63V1	1	Self-Adhesive Vinyl	£2.45	£2.25	£2.70
SS63V10	10	Self-Adhesive Vinyl	£23.45	£19.95	£23.94

CUT & IMPACT RESISTANT GLOVES - PAIRS



- Durable HPPE knitting provides cut resistance to level C.
- Anti-slip coating on the palm of the glove to give greater control to use in wet or oily environments.
- Additional reinforcement at thumb crotch for enhanced protection.
- Impact resistant TPR material on the back of the glove to help protect knuckles, fingers and thumbs during use.
- Hook-and-loop wrist strap.
- Performance Levels - 4X43CP.
- **Model No. SSP3BL - Large**
- **Model No. SSP3BXL - X-Large**
- List Price £19.95

£13.95 Exc. VAT
£16.74 Inc. VAT

DELUXE FACE SHIELD WITH POWERED AIR PURIFYING RESPIRATOR (PAPR)



EN 12941 is the European standard for a complete powered air filtering device incorporating a face helmet or visor.

This standard outlines three classes of performance, which define the following maximum levels of inward leakage*: 10% for TH1, 2% for TH2 and 0.2% for TH3 (see individual Model No's for TH classification).

*Inward Leakage estimates the performance of a respiratory device by measuring contaminants that leak through a respirator from various sources, including filter penetration, face seals, valves & gaskets.

- Lithium battery powered respirator unit provides the user a constant filtered stream of air to their head and face for up to approximately 8 hours.
- The filter assembly, consisting of a foam pre-filter and HEPA filter, is designed to reduce or remove dust and particles but not vapours and gases.
- The kit meets performance class TH2 according to EN 12941:1998/A2:2008.
- Adjustable airflow settings of 150-180L/min.
- Features an audible alarm to alert user of low battery/low airflow.
- Polycarbonate visor for increased protection, stability, and durability.
- Ratchet adjustable headband with front and back padding for extra comfort.
- Suitable for use with standard glasses.
- Face shield conforms to BS EN 166, Optical Class 1, Impact Grade F.
- **Model No. SSP80PAPR**
- List Price £379.95



£319.95 Exc. VAT
£383.94 Inc. VAT

STANDARD GOGGLES - INDIRECT VENT PACK OF 10



- Clear polycarbonate safety lens with indirect ventilation in the frame.
- Conforms to BS EN 166, optical class 1 impact grade B.
- **Model No. 201/10**
- List Price £44.45

£17.95 Exc. VAT
£21.54 Inc. VAT

HALF MASK WITH A2P3R FILTER CARTRIDGES



- Lightweight and dermatologically friendly made from soft thermoplastic elastomer.
- Built-in exhalation vent makes breathing out easy and comfortable without letting harmful materials in.
- Threaded cartridges makes connecting filters easy and efficient.
- Ideal for a variety of painting, sanding and wood & metal cutting tasks.
- Adjustable straps in order to optimize comfort and support.
- Supplied with 2 x A2P3R filters for protection against organic vapour and particulate.
- Maximum user levels 5000ppm or 30 x OEL, whichever is lower.



Model No.	Description	List Price	Exc. VAT	Inc. VAT
9360/66	Half Mask with Filter Cartridges	£64.95	£43.95	£52.74
9366	Replacement Filters - Pack of 2	£46.95	£32.95	£39.54

**195PC NUMBERPLATE SCREW ASSORTMENT
PLASTIC ENCLOSED HEAD**



- Numberplate screws.
- Plastic enclosed head.
- Quantity: 195 (65 of each colour).
- Colours: Black, Yellow, White.
- Supplied in partitioned box.
- **Model No. AB195NP**
- List Price £49.95

£32.95 Exc. VAT
£39.54 Inc. VAT

**425PC ACME SCREW WITH CAPTIVE
WASHER ASSORTMENT**



- Sheet metal screw (Acme bolt) assortment.
- Captive washer.
- BS 7976/6903.
- Quantity: 425.
- Supplied in a partitioned box.
- **Model No. AB425AS**
- List Price £89.95

£59.95 Exc. VAT
£71.94 Inc. VAT

**160PC BLEED NIPPLE
ASSORTED BOX**



- Contents: Brake Bleed Screw Set; 3/8"UNF x 38mm 24tpi (x10), 3/8"UNF x 32mm 24tpi (x20), M6 x 29mm 1mm Pitch (x40), 1/4"UNF x 28mm 28tpi Long (x10), M8 x 24mm 1.25mm Pitch (x20), M7 x 28mm 1mm Pitch (x10), M10 x 30mm 1mm Pitch (x20), M10 x 25mm 1mm Pitch (x30).
- **Model No. AB160BN**
- List Price £149.95

£99.95 Exc. VAT
£119.94 Inc. VAT

**BI-METAL HACKSAW BLADES HSS
PACKS OF 5**

Model No. HSB0518



- 300mm Flexible bi-metal HSS blades.
- Superior performance on a wide range of materials.

Model No.	Tooth Pitch	List Price	Exc. VAT	Inc. VAT
HSB0518	18tpi	£11.95	£8.45	£10.14
HSB0524	24tpi	£11.95	£8.45	£10.14
HSB0532	32tpi	£11.95	£8.45	£10.14

**STUD WELDING NAILS
PACKS OF 200**

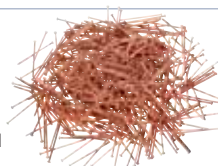

- Copper coated pins for use with dent pulling stud welders.

**50mm X 50m ENGINEER'S
EMERY ROLL - 320GRIT**



- Designed for rust removal, finishing and polishing.
- Not for use on wood.
- **Model No. ERB5050320**
- List Price £28.45

£18.95 Exc. VAT
£22.74 Inc. VAT

Model No.	Size	List Price	Exc. VAT	Inc. VAT
PS/000350/200	2 x 50mm	£18.95	£15.45	£18.54
PS/000250/200	2.5 x 50mm	£19.95	£16.45	£19.74

**Ø12mm RUBBER LINED P-CLIP
PACK OF 25**



- Rubber lined P-clip.
- Manufactured to DIN 3016.
- Zinc plated.
- Suitable for use on cables, piping and tubing.
- **Model No. PCJ12**
- List Price £8.15

£5.45 Exc. VAT
£6.54 Inc. VAT

MIG CONSUMABLES KIT



Package includes:

- 120.802032 - No Gas/Gas Conversion Kit
- CO2/101 - Gas Cylinder
- Disposable Carbon Dioxide 600g
- MIG/7K06 - Mild Steel MIG Wire 0.7kg Ø0.6mm A18 Grade
- MIG956 - Contact Tip 0.6mm MB15 Pack of 5
- **Model No. MIGKIT**
- List Price £109.95

£74.95 Exc. VAT
£89.94 Inc. VAT

**ULTRASONIC
CLEANING FLUID**

- Safely removes dirt, grease and oil.
- To eliminate risk, a sample should be used to test the suitability of the product.
- Always be sure to dilute solution to the required strength.



- **Model No. SCT25D**
- List Price £169.95

£119.95 Exc. VAT
£143.94 Inc. VAT

OXYACETYLENE GAS WELDING/CUTTING SET

- Single stage gas regulators with two gauges to show bottle pressure and working pressure.
- 4.5m Twin gas hose set with hose check valves (to torch) and EN 730-compliant pressure activated flash arrestors (to regulators).
- Welding torch with three lightweight nozzles.
- Cutting torch attachment with three ANMS cutting nozzles.
- Spark lighter.
- **Model No. SGA1B**
- List Price £369.95



£299.95 Exc. VAT
£359.94 Inc. VAT

5L HEAVY-DUTY WHEEL CLEANER



5L



- **Model No. SCT5D**
- List Price £37.95

£28.95 Exc. VAT
£34.74 Inc. VAT

- Heavy-duty alkaline (non-acidic) concentrated formula ideal for removing brake dust and general wheel grime.
- Especially suitable for alloy wheels.
- Dilute ten parts water to one part wheel cleaner.
- Recommended to be applied with low pressure sprayer, then rinsed off with higher water pressure after allowing a few minutes for solution to activate.
- **Model No. SCS009**
- List Price £29.95

£23.95 Exc. VAT
£28.74 Inc. VAT

ALL OUR NEWEST PRODUCTS IN ONE PLACE

We are continuously expanding the Sealey range to bring you the very latest technology in tools and equipment.

SEE PAGE 38
Portable Power Banks

SEE PAGE 18
Video Borescopes



SEE PAGE 23
8V Cordless Grease Gun



SEE PAGE 39
4 Drawer Rollcab & 3 Drawer Utility Seat

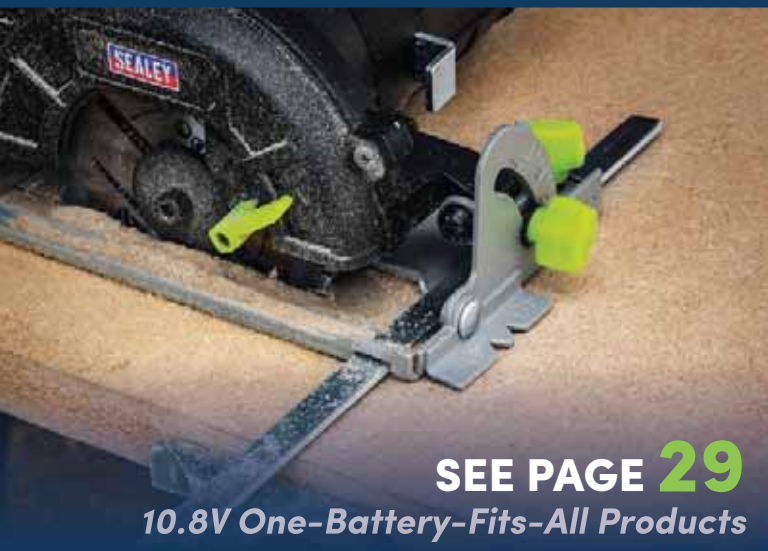

SEE PAGE 29
10.8V One-Battery-Fits-All Products



SEE PAGE 14
Mechanic's Detailing Utility Seats



Download, view or request our full catalogue at sealey.co.uk.

Promotion valid:
1st September 2022 to 31st March 2023

Reference Code: NL2022

Call +44 (0)1284 757500
Email sales@sealey.co.uk
Web www.sealey.co.uk
Post Sealey Group, Kempson Way,
Suffolk Business Park,
Bury St Edmunds, Suffolk. IP32 7AR



When you have finished with this magazine please recycle it.

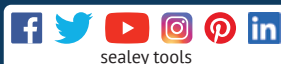

YOUR LOCAL STOCKIST

Offers will be withdrawn when stock is sold. Prices exclude VAT unless otherwise stated. We reserve the right to withdraw offers, substitute products and change pricing at any time. Specifications and descriptions on this promotion are given in good faith but may change without notice and do not form any part of a sale contract, E & OE.

*Please refer to www.sealey.co.uk/guarantee for more information on guarantees. TRX-STAR, TRX-TS and TRX-P tools are suitable for driving TORX® and TORX PLUS® fasteners respectively. TORX® and TORX PLUS® are registered trademarks of Acument Intellectual Properties, LLC.