

The Viking Lite valve range is robust, versatile and combines high performance with compact installation dimensions. Large flow capacity, short change-over times and low change-over pressure are important characteristics of this valve range.

Designed to operate with pressures up to 10 bar in temperatures -10°C to + 50°C.



- 3 sizes: G1/8, G1/4 and G3/8.
- Large flow capacity with short change-over times.
- Low change over pressure.
- Dynamic bi-directional spool seals.
- Do not require lubrication in operation but can also be installed in systems that are lubricated.

Operating information

	P2L-AZ	P2L-BZ	P2L-CZ
Port size:	G1/8	G1/4	G3/8
Working pressure:	10 bar	10 bar	10 bar
Working temperature	-10 °C to +50 °C		
Flow (Qmax);	15,6 l/s	37,8 l/s	68,3 l/s

For more information see www.parker.com/euro_pneumatic

Solenoid operated directional control valves

Internal supply to solenoid valve(s) via port 1.

3/2 valves, internal air, standard temperature

Symbol	Size	Actuation	Return	Min Operating Pressure (bar)	Changeover time (ms) at 6 bar @20°C actua./return	Weight Kg	Order code Without coil	Order code With 24V DC (22mm coil)
	G1/8	Electric signal	Electric signal	1,5	10/10	0,18	P2LAZ311EENDCN	P2LAZ311EENDCB49
	G1/4			1,5	12/12	0,18	P2LBZ312EENDCN	P2LBZ312EENDCB49
	G3/8			1,5	17/17	0,36	P2LCZ313EENDCN	P2LCZ313EENDCB49
	G1/8	Electric signal	Spring	3,0	15/35	0,16	P2LAZ311ESNDCN	P2LAZ311ESNDCB49
	G1/4			3,0	18/45	0,16	P2LBZ312ESNDCN	P2LBZ312ESNDCB49
	G3/8			3,0	27/75	0,35	P2LCZ313ESNDCN	P2LCZ313ESNDCB49

5/2 valves, internal air, standard temperature

Symbol	Size	Actuation	Return	Min Operating Pressure (bar)	Changeover time (ms) at 6 bar @20°C actua./return	Weight Kg	Order code Without coil	Order code With 24V DC (22mm coil)
	G1/8	Electric signal	Electric signal	1,5	10/10	0,19	P2LAZ511EENDCN	P2LAZ511EENDCB49
	G1/4			1,5	12/12	0,21	P2LBZ512EENDCN	P2LBZ512EENDCB49
	G3/8			1,5	17/17	0,44	P2LCZ513EENDCN	P2LCZ513EENDCB49
	G1/8	Electric signal	Spring	3,0	15/35	0,17	P2LAZ511ESNDCN	P2LAZ511ESNDCB49
	G1/4			3,0	18/45	0,20	P2LBZ512ESNDCN	P2LBZ512ESNDCB49
	G3/8			3,0	27/75	0,43	P2LCZ513ESNDCN	P2LCZ513ESNDCB49

5/3 valves, internal air, standard temperature

Symbol	Size	Actuation	Min Operating Pressure (bar)	Changeover time (ms) at 6 bar @20°C actua./return	Weight Kg	Order code Without coil	Order code With 24V DC (22mm coil)
	G1/8	Self centring	3,0	18/40	0,26	P2LAZ611EENDCN	P2LAZ611EENDCB49
	G1/4	Electric/Electric Closed	3,0	22/55	0,28	P2LBZ612EENDCN	P2LBZ612EENDCB49
	G3/8	Centre	3,0	30/90	0,60	P2LCZ613EENDCN	P2LCZ613EENDCB49
	G1/8	Self centring	3,0	18/40	0,26	P2LAZ711EENDCN	P2LAZ711EENDCB49
	G1/4	Electric/Electric Presurised	3,0	22/45	0,28	P2LBZ712EENDCN	P2LBZ712EENDCB49
	G3/8	Centre	3,0	30/90	0,60	P2LCZ713EENDCN	P2LCZ713EENDCB49
	G1/8	Self centring	3,0	18/40	0,26	P2LAZ811EENDCN	P2LAZ811EENDCB49
	G1/4	Electric/Electric Vented	3,0	22/45	0,28	P2LBZ812EENDCN	P2LBZ812EENDCB49
	G3/8	Centre	3,0	30/90	0,60	P2LCZ813EENDCN	P2LCZ813EENDCB49

Note: All valves may be ordered with non locking manual override, replacing

...**CN** with ...**BN**

...**CB49** with ...**BB49**

Viking Lite

Available in boxed quantities of 25



5/2 valves, internal air, standard temperature

The Viking Lite valve is available in boxed quantities of 25 combines high performance with compact installation dimensions. Large flow capacity, short change-over times and low change-over pressure are important characteristics of this valve range.

Size	Actuation	Return	Order code Without solenoid	Order code With 24V DC (22mm coil)
G1/8	Electric	Electric	P2LAZ511EENDCNQ25	P2LAZ511EENDCB49Q25
G1/4	signal	signal	P2LBZ512EENDCNQ25	P2LBZ512EENDCB49Q25
G1/8	Electric	Spring	P2LAZ511ESNDCNQ25	P2LAZ511ESNDCB49Q25
G1/4	signal		P2LBZ512ESNDCNQ25	P2LBZ512ESNDCB49Q25

Dimensions

P2LAZ 3/2
Solenoid / Solenoid

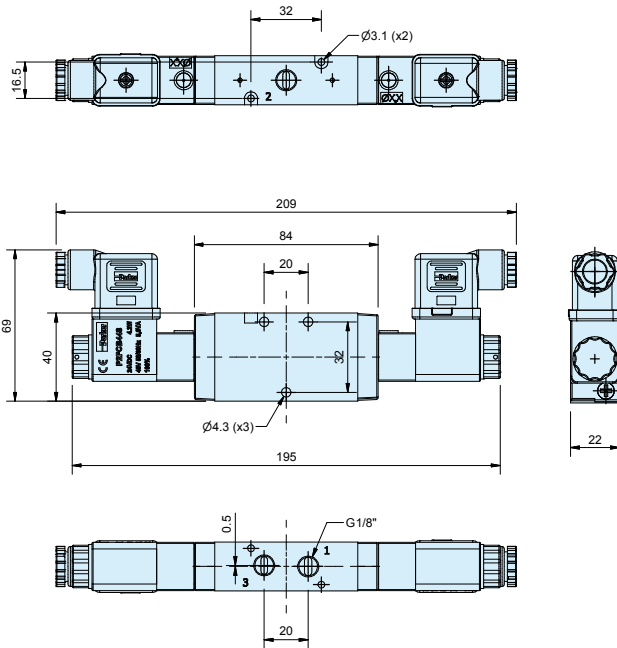

P2LAZ 3/2
Solenoid / Spring

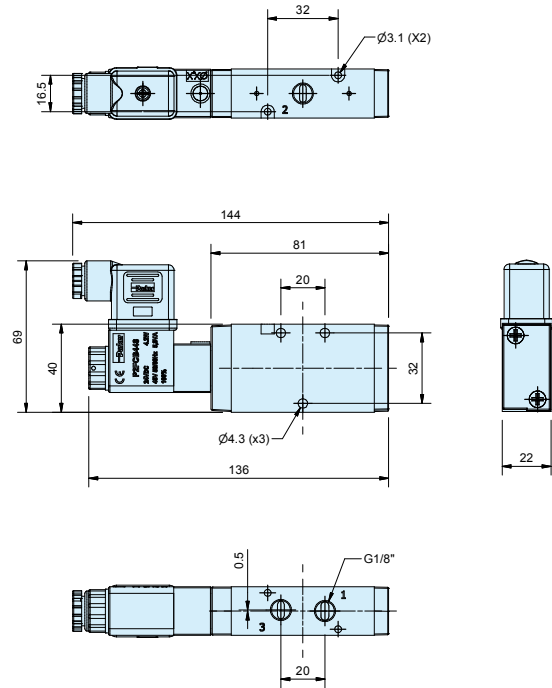

P2LAZ 5/2 and 5/3
Solenoid / Solenoid

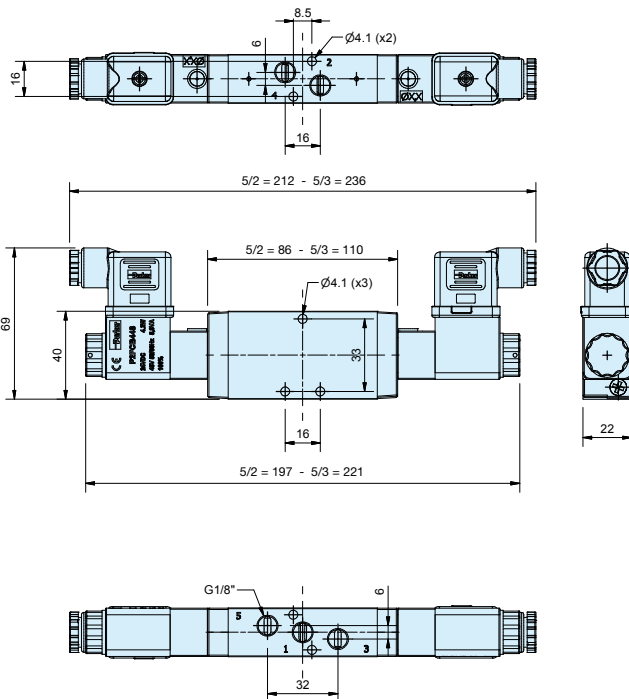

P2LAZ 5/2
Solenoid / Spring

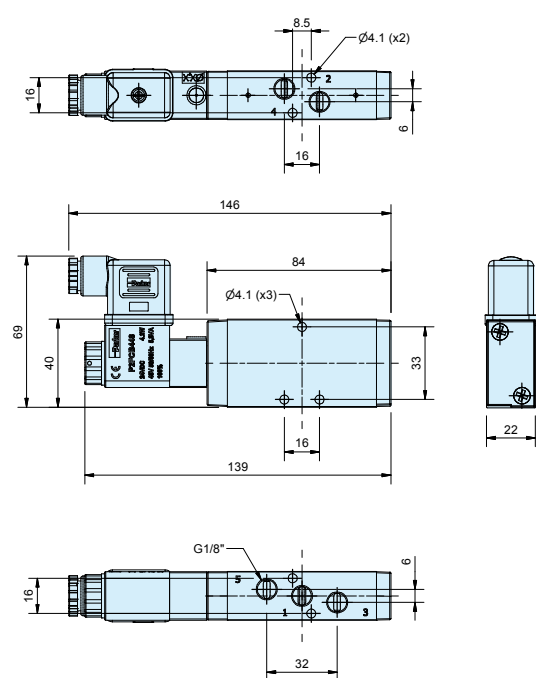

Solenoid valves

Solenoid valves and cable plugs must be ordered separately. One pilot valve is required for each E (NDCN only) in the valve order code.

Dimensions

P2LBZ 3/2
 Solenoid / Solenoid

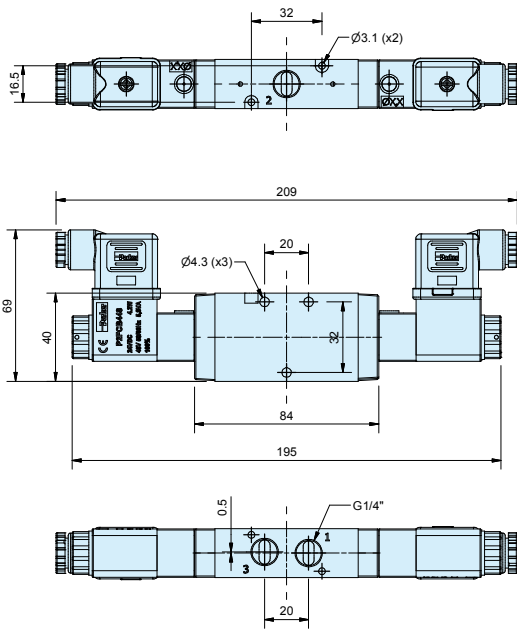

P2LBZ 3/2
 Solenoid / Spring

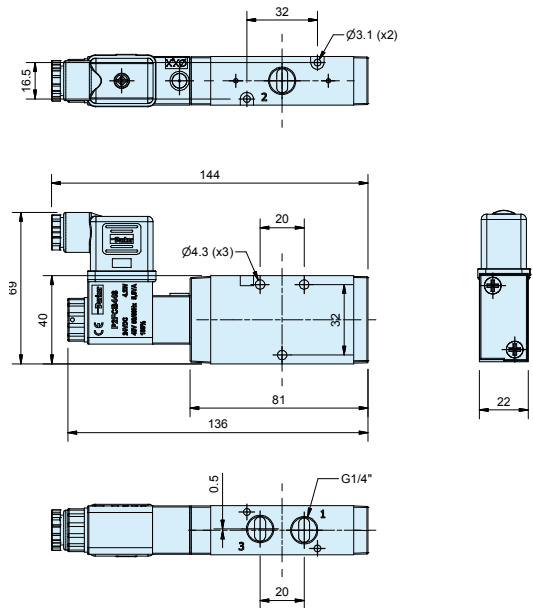

P2LBZ 5/2 and 5/3
 Solenoid / Solenoid

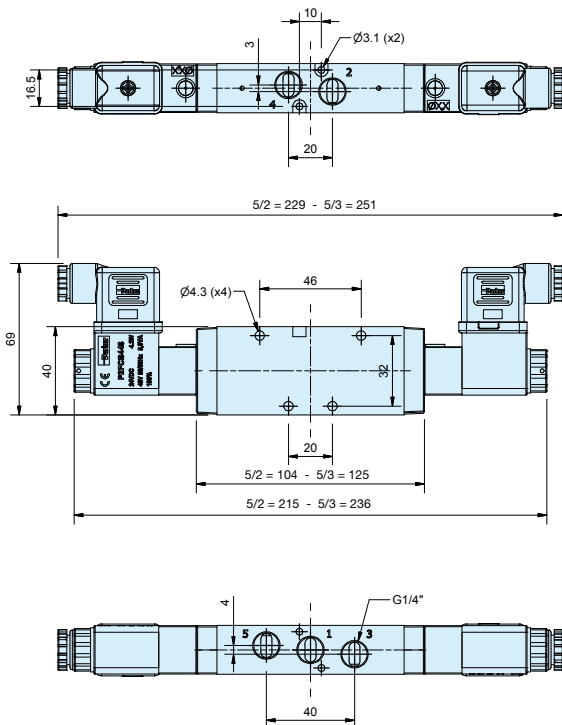

P2LBZ 5/2
 Solenoid / Spring

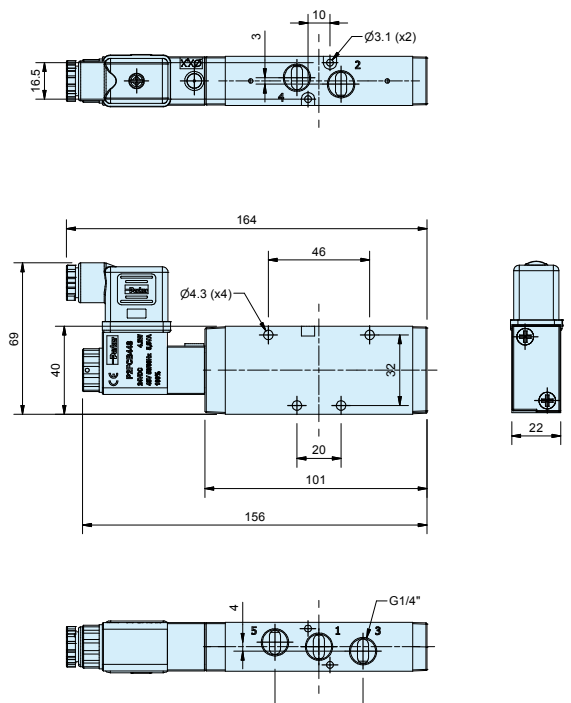

Solenoid valves

Solenoid valves and cable plugs must be ordered separately. One pilot valve is required for each E (NDCN only) in the valve order code.

Dimensions

P2LCZ 3/2
Solenoid / Solenoid

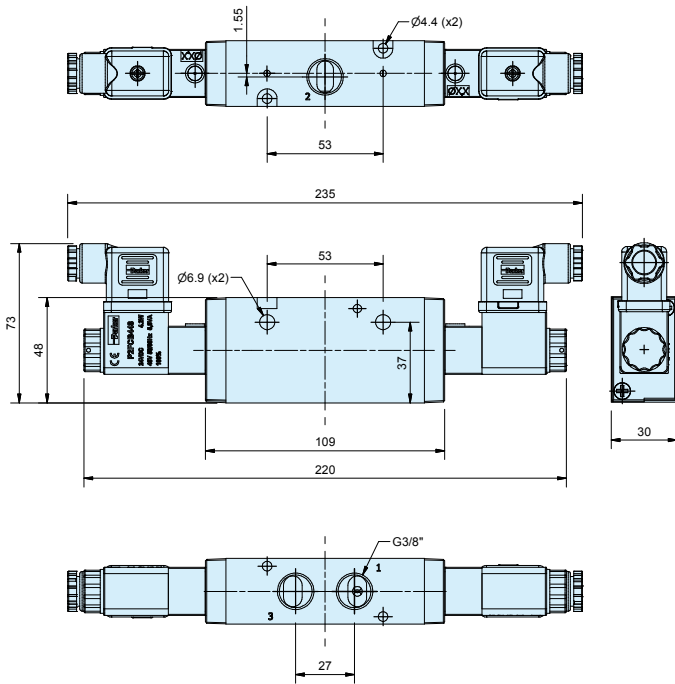

P2LCZ 3/2
Solenoid / Spring

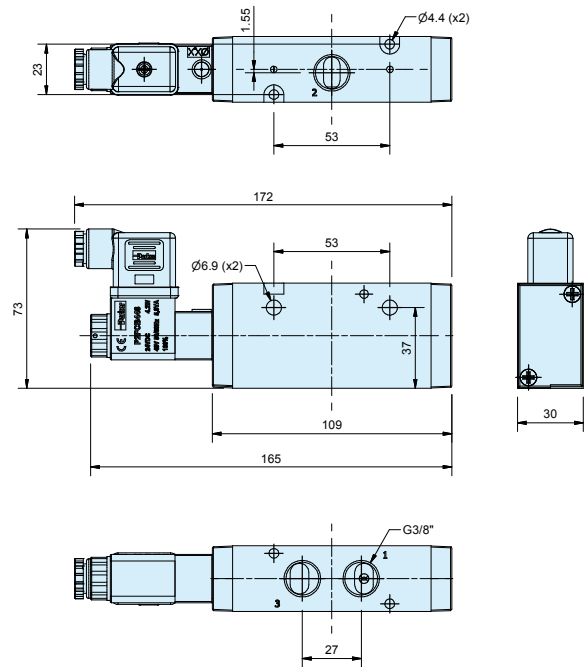

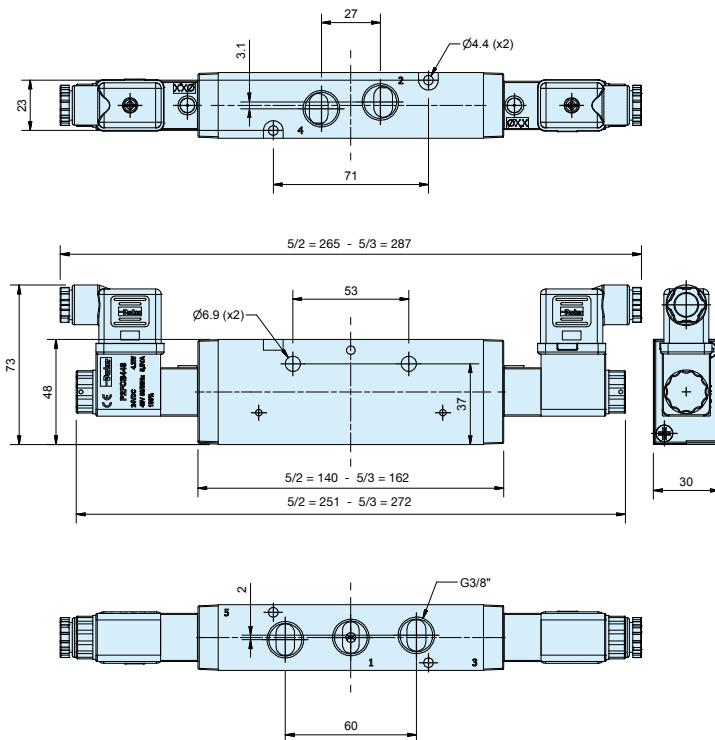

P2LCZ 5/2 and 5/3
Solenoid / Solenoid

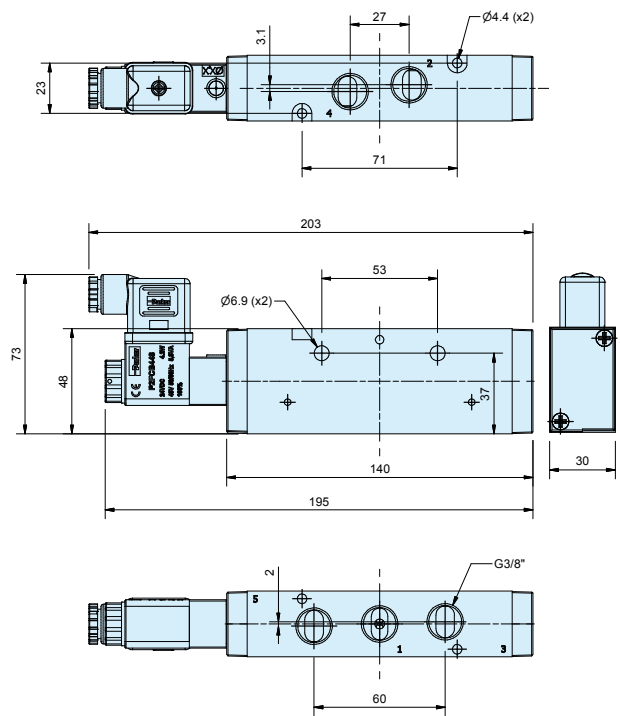

P2LCZ 5/2
Solenoid / Spring



Accessories	Type P2LA / P2LB 3/2 valves	Weight kg	Order code
	Manifold bar, P2LB incl. fasteners and O-ring. G3/8		
	For 2 valves	0,38	91213202SXZ
	For 4 valves	0,64	91213204SXZ
	For 6 valves	0,89	91213206SXZ
	For 8 valves	1,15	91213208SXZ
	For 10 valves	1,40	91213210SXZ
	Blanking plate for Manifold bar	0,10	912132BPSXZ

Dimensions



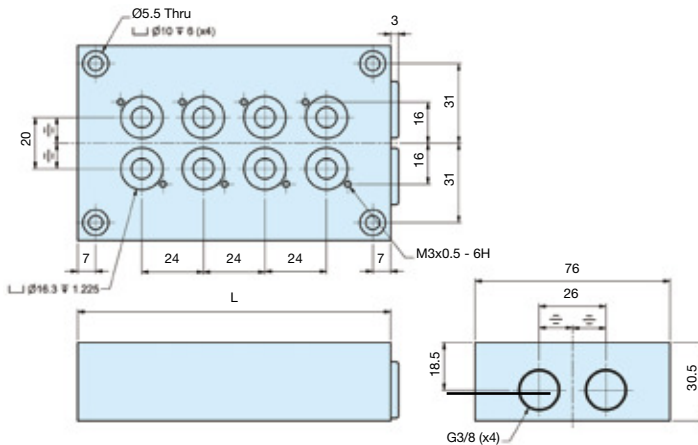



Manifold bar

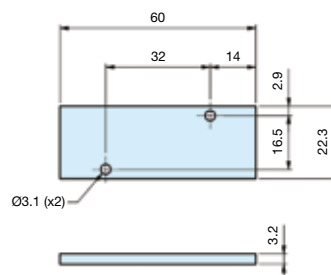

No. of valves	L mm
2	74
4	122
6	170
8	218
10	266

Blanking plate for manifold bar, P2LB



Accessories	Type P2LA 5/2 valves	Weight kg	Order code
	Manifold bar, P2LA including seals, mounting screws. G3/8 For 4 valves For 6 valves For 8 valves For 10 valves For 12 valves For 14 valves	0,48 0,63 0,80 0,98 1,10 1,23	9121658075 9121658076 9121658077 9121658078 9121658079 9121658099
	Blanking plate, P2LA for Manifold bar	0,05	9121658063
	Pressure bar, P2LA for common air supply incl. O-rings and mounting screws. G1/4 For 2 valves For 4 valves For 6 valves For 8 valves	0,13 0,20 0,26 0,33	9121658070 9121658071 9121658072 9121658073
	Blanking plate, P2LA for Pressure bar	0,05	9121658074
	Assembly screws, P2LA in stainless steel for valve	0,02	9121658043
	Assembly screws, P2LA in stainless steel for blanking plate	0,01	9121658044
	O-ring kit, P2LA O-rings between valve and manifold bar/Pressure bar	0,01	9121658046

Dimensions

Manifold bar, P2LA

No. of valves	L mm
4	126
6	174
8	222
10	270
12	318
14	366

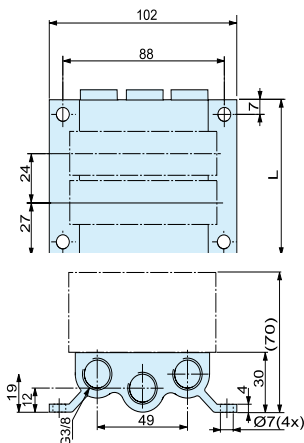

Blanking plate for manifold bar, P2LA

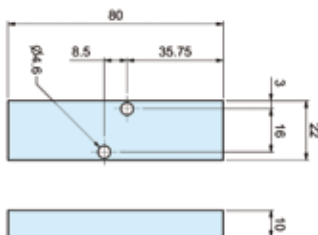



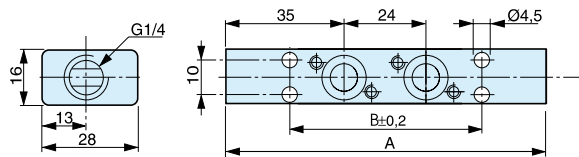

Pressure bar, P2LA

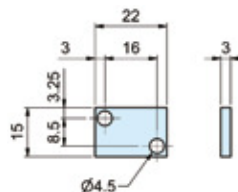

Blanking plate for pressure bar, P2LA



No. of valves	A mm	B mm
2	94	56
4	142	104
6	190	152
8	238	200

Accessories	Type P2LB 5/2 valves	Weight kg	Order code		
	Manifold bar, P2LB incl. fasteners and O-ring. G3/8 For 2 valves For 4 valves For 6 valves For 8 valves For 10 valves	0,69 1,13 1,56 2,00 2,45	9121594805X 9121594806X 9121594807X 9121594808X 9121594812X		
		Blanking plate, P2LB for Manifold bar	0,10	9121594809X	
		Pressure bar, P2LB for common air supply incl. O-rings and mounting screws. G3/8 For 2 valves For 4 valves For 6 valves For 8 valves For 10 valves	0,38 0,53 0,68 0,83 0,99	9127113301X 9127113302X 9127113303X 9127113304X 9127113305X	
			Blanking plate P2LB for Pressure bar. G1/4	0,02	9127113306X

Dimensions

Manifold bar, P2LB

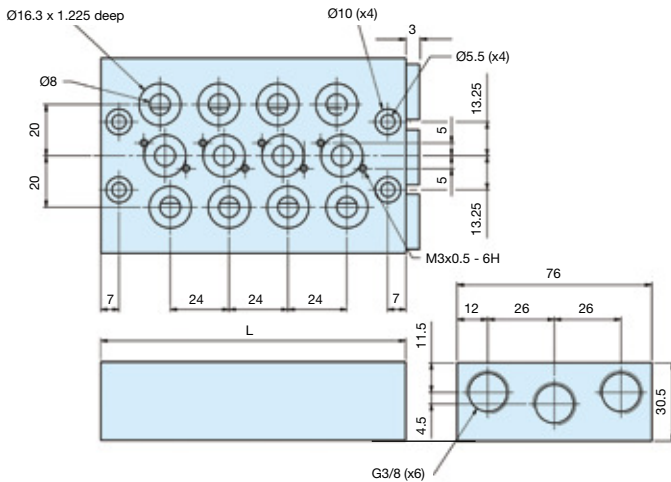

No. of valves	L mm
2	74
4	122
6	170
8	218
10	266

Blanking plate for manifold bar, P2LB

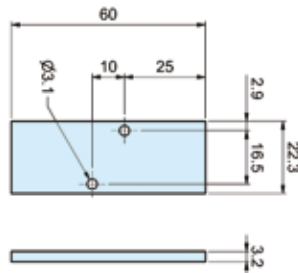

Pressure bar, P2LB

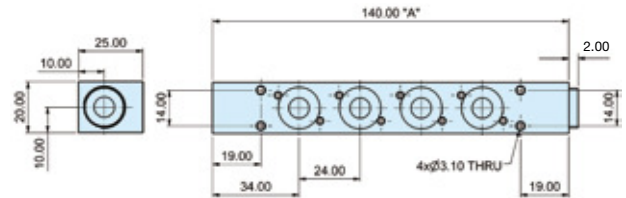

Blanking plate for pressure bar, P2LB

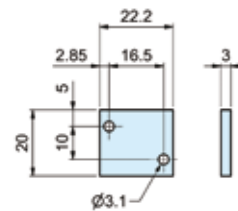

No. of valves	A mm
2	92
4	140
6	188
8	236
10	284

22mm solenoid operator part numbers and spares

Solenoid coils for 22mm solenoid operators

Voltage	Weight (Kg)	Order code Form B
12V 60Hz	0.093	P2FCB340
24V 50/60Hz	0.093	P2FCB342
12V DC	0.093	P2FCB345
24V DC	0.093	P2FCB349
48V DC	0.093	P2FCB351
110V/50Hz, 120V/60Hz	0.093	P2FCB353
230V/50Hz, 230V/60Hz	0.093	P2FCB357

Spare Solenoid Nuts

Valves requiring captured exhaust should be fitted with plastic knurled nut

Order code
P2FNP

Valves with vented exhaust are fitted with diffuser plastic nut

Order Code
P2FND

Solenoid Connectors / Cable Plugs EN175301-803

	Description	Order code 22mm Industrial Form B
With standard screw	Standard IP65 without flying lead	3EV10V10
	With LED and protection 24V AC/DC	3EV10V20-24
	With LED and protection 110V AC	3EV10V20-110
	With LED and protection 230V AC	3EV10V20-230
With cable	24V AC/DC, 5m cable LED and protection IP65	3EV10V20-24L5
	110V AC/DC, 5m cable LED and protection IP65	3EV10V20-110L5
	230V AC, 5m cable LED and protection IP65	3EV10V20-230L5

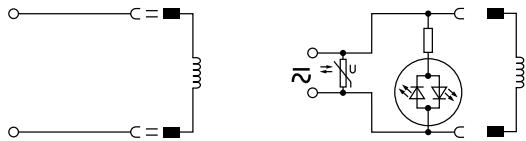

3EV10V10	3EV10V20-24	3EV10V20-24L5
	3EV10V20-110	3EV10V20-110L5
	3EV10V20-230	3EV10V20-230L5

Cable Plug Dimensions (mm)

